

LiveAction



LiveWire

User Guide

LiveAction, Inc.
901 Campisi Way, Ste. 222
Campbell, CA 95008, USA
+1 (888) 881-1116
<https://www.liveaction.com>

Copyright © 2024 LiveAction, Inc.
All rights reserved

20240712-LWG2U_2420a

On-site Hardware Warranty

WARRANTY COVERAGE

We, LiveAction (the trading name of LiveAction, Inc.), warrant that the hardware product ("Product") you have purchased, shall be free from defects in materials and workmanship for the period of your On-site Hardware Warranty from the date of original purchase. This Hardware Warranty does not cover any software you may have purchased from LiveAction, which would be the subject of a separate license agreement. We will, at our option, either repair, replace or refund the price you have paid for the Product which has failed within the warranty period by reason of faulty design (other than any design made, furnished or specified by you) or faulty workmanship or defective materials.

OBTAINING WARRANTY SERVICE

In the event of Product failure, you must contact us within the warranty period in order to notify us of the failure and obtain a Return Material Authorization number for prompt return of the product for repair or replacement. When the failed component is determined, it will be ordered as soon as possible and support technician will replace the part at the site. This process might take few days depending on the availability of the failed parts. Parts will be shipped from the U.S.

- a. It is your responsibility to back up the contents of any and all hard drives shipped to us for warranty service. We will not be responsible for damage to or loss of any programs, data or other information stored on any media.
- b. If it is determined that the Product cannot be repaired or replaced, LiveAction may, at its sole discretion, refund the price of the Product.
- c. Any replaced parts will be warranted for the remainder of the original warranty period.
- d. If your Product needs to be shipped to LiveAction, the customer is responsible for that shipping. LiveAction will ship repaired or replacement product freight prepaid within the U.S.
- e. If your Product is moved outside of the country purchased, LiveAction must be notified of the move immediately so that there will be no delay in obtaining onsite parts/labor.

EXCLUSIONS AND LIMITATIONS

This warranty covers only the hardware components packaged with the original LiveAction Product. Software, external devices, and accessories or parts added after the Product is shipped from LiveAction are not covered under this warranty. Damage occurring during the original shipment of LiveAction Product to you is not covered under this limited warranty. Damage due to external causes, including accident, abuse, misuse, problems with electrical power, servicing or modifications not authorized in writing by LiveAction, improper installation, usage not in accordance with product instructions and problems caused by use of parts and components not supplied by us is not covered under this limited warranty. No LiveAction agent, employee, or affiliate is authorized to make any modification, extension, or addition to this limited warranty.

IF THIS PRODUCT DOES NOT PERFORM AS DESCRIBED IN THE PRODUCT'S DOCUMENTATION OR IS OTHERWISE DEFECTIVE, WE SHALL NOT BE LIABLE IN ANY EVENT FOR DAMAGES, LOST PROFITS, REVENUE, ANTICIPATED SAVINGS OR ANY OTHER INCIDENTAL, INDIRECT, SPECIAL OR CONSEQUENTIAL DAMAGES ARISING FROM THE PURCHASE, USE OR INABILITY TO USE THIS PRODUCT. WE SHALL HAVE NO LIABILITY WHATSOEVER FOR OR AS A RESULT OF THE CONDITION OF THE PRODUCT OR ITS FITNESS OR SUITABILITY FOR ANY PARTICULAR PURPOSE. Some states do not allow exclusions or limitations, so the above may not apply to you. This limited warranty gives you specific legal rights, and you may have other rights, which vary from state to state.

If, upon inspection, it is found that the returned Product is not defective within the terms of this limited warranty, you shall pay our standard repair charges to repair the Product including inspection costs and all transport and shipping costs associated with returning the Product to you. Any product or part supplied under this limited warranty may be new or reassembled or reconditioned from serviceable new and used parts. All defective Product or parts will become our property.

EXCEPT FOR THE EXPRESS WARRANTIES STATE ABOVE, LIVEACTION DISCLAIMS ALL WARRANTIES (EXPRESS, IMPLIED STATUTORY OR OTHERWISE) RELATING TO THE PRODUCT, INCLUDING, BUT NOT LIMITED TO ANY IMPLIED WARRANTIES OF MERCHANTABILITY, FITNESS FOR A PARTICULAR PURPOSE OR NON-INFRINGEMENT, AND ANY WARRANTIES THAT MAY ARISE FROM COURSE OF PERFORMANCE OR USAGE OF TRADE. IN ADDITION, THE REMEDIES SET FORTH ABOVE CONSTITUTES THE SOLE REMEDIES FOR YOU AND SOLE OBLIGATION OF US FOR BREACH OF WARRANTY OR OTHER CLAIM WITH RESPECT TO THE PRODUCT. YOU ACKNOWLEDGE THAT LIVEACTION HAS SET ITS PRICES AND ENTERED INTO THESE TERMS IN RELIANCE UPON THE LIMITATION OF LIABILITY AND THE DISCLAIMERS OF WARRANTIES AND DAMAGES SET FORTH HEREIN, AND THAT THE SAME FORM AN ESSENTIAL BASIS OF THE BARGAIN BETWEEN THE PARTIES. YOU AGREE THAT THE LIMITATION AND EXCLUSIONS OF LIABILITY AND DISCLAIMERS SPECIFIED IN THESE TERMS WILL SURVIVE AND APPLY EVEN IF FOUND TO HAVE FAILED OF THEIR ESSENTIAL PURPOSE.

ADDITIONAL INFORMATION

Product Information: www.liveaction.com.

Support Contact Information: <https://www.liveaction.com/support/technical-support/>

LiveAction Global Next Business Day (NBD) Response Warranty Support Statement

Global NBD Response Warranty Includes

Direct telephone and email access to senior-level analysts for expedited troubleshooting of hardware issues. On-Site dispatch of service technician and/or warranty parts to Customer's business location for repairs and resolution necessary due to a defect in materials or workmanship on the Supported System.

Support Procedures

Support Requests: Customer may submit the issue and a service request by contacting LiveAction technical support at <https://www.liveaction.com/support/technical-support/>.

Assist with phone/email-based Troubleshooting

- When request is submitted, please include serial number of unit. Be prepared to identify any error messages received, how and when they occurred, and what activities preceded the error. Also be able to describe what steps have already been taken to solve the problem.
- Analyst will go through a series of additional troubleshooting steps to help diagnose the issue.
- If an on-site dispatch and parts replacement is necessary, the analyst will provide Customer with additional instructions.
- An RMA (Return Merchandise Authorization) will be created and any defective parts will be replaced.

On-Site Support

The On-Site Support includes 24x7 next business day response with repair if parts are available. If parts are not available, the repair will take place the day after the parts arrive at the Customer location.

A service technician will be dispatched to the business location of the affected system. Customer will be contacted in advance to schedule the onsite visit.

On-site Response Time Restrictions/Special Terms

With Next Business Day On-Site Response Service following phone-based/Email troubleshooting, a technician can usually be dispatched to arrive onsite the next business day.

- Available 5 days/week, 8 hours/day - excluding holidays.
- Calls received 5:00 PM local Customer time (Monday - Friday) and/or dispatches made after that time may require an additional business day for service technician to arrive at the Customer's location.

Following completion of remote troubleshooting and problem determination, the analyst will determine if the issue requires an on-site service technician and/or parts to be dispatched or if the issue can be resolved remotely over the phone.

Missed Service Visit: If Customer or Customer's authorized representative is not at the location when the service technician arrives, the service technician cannot service the Supported System. The service technician will leave and customer will be notified and the next appointment will be scheduled. If this occurs, Customer may be charged an additional fee for a follow-up service call.

Software Troubleshooting

Support includes software troubleshooting for select applications and operating systems on Supported Systems over the telephone, or by transmission of software and other information through electronic means, or by shipping software and/or other information to Customer. Covered Software Products include core operating systems, which is installed and Supported by LiveAction.

Software Troubleshooting Does Not Include*

- Any product version not currently supported or provided by the manufacturer.
- Configuration, installation or optimization assistance.
- Any on-site service.
- Remote or on-site training assistance.

*LiveAction software maintenance covers Capture Engine Software maintenance and support.

Global NBD Response Warranty Does Not Include

- LiveWire Edge hardware.
- Accessories, supply items, operating supplies, peripherals or parts such as batteries, frames, and covers.
- Media replacement for software LiveAction no longer ships with new systems.
- Media replacement on non-LiveAction branded / manufactured software.
- Hardware or software support for Customer Factory Integration ("CFI") products.
- Hardware or software support for non-LiveAction peripherals.
- Preventative maintenance.

- Installation, de-installation, or relocation services.
- Direct third party product support.
- Repairs necessitated by software problems, or as a result of alteration, adjustment, or repair by anyone other than LiveAction (or its authorized representatives).
- Support for equipment damaged by misuse, accident, abuse of Supported System or components (such as, but not limited to, use of incorrect line voltages, use of incorrect fuses, use of incompatible devices or accessories, improper or insufficient ventilation, or failure to follow operating instructions), modification, unsuitable physical or operating environment, improper maintenance by Customer (or Customer's agent), moving the Supported System, removal or alteration of equipment or parts identification labels, or failure caused by a product for which LiveAction is not responsible.
- Support for damage resulting from an act of God such as, but not limited to, lightning, flooding, tornado, earthquakes, and hurricanes.
- Any activities or services not expressly described in this Service Description. Please read this Service Description carefully and note that LiveAction reserves the right to change or modify any of the terms and conditions set forth in this Service Description at any time, and to determine whether and when any such changes apply to both existing and future Customers.

Contents

Chapter 1	Introduction	1
	About LiveWire	2
	What's included	3
	Front / rear panels	4
	LiveWire Edge front panel	4
	LiveWire Edge rear panel	5
	LiveWire Core front panel	6
	LiveWire Core back panel	7
	LiveWire PowerCore front panel	8
	LiveWire PowerCore back panel	8
	LiveWire StorageCore front panel	10
	LiveWire StorageCore back panel	11
	Inside the appliance	11
	LiveWire Core internal components	12
	LiveWire PowerCore internal components	14
	LiveWire StorageCore internal components	16
	Installing LiveWire	16
	LiveWire Edge	16
	LiveWire Core/PowerCore/StorageCore	18
	Connecting network cables	19
	System fans	19
	Connecting TeraVault to LiveWire PowerCore	19
	Connecting multiple TeraVault units	21
	LiveWire Activation	22
	Activation via Omnippeek Web	22
	Activation via Omnippeek	25
	Starting / shutting down LiveWire	30
	Attaching the front bezel	30
	Contacting LiveAction support	30
Chapter 2	Configuring LiveWire	31
	Logging-in to LiveWire command line	32
	Using the LiveAdmin utility	32
	Login	33
	Dashboard	34
	Authentication	35
	Monitor	36
	Network	37
	Omni	39
	Support	44
	Remote Syslog	45
	Time	45
	TLS	46
	Update	46
	Restart and power off	47
	Using Grid to manage and configure LiveAction appliances	47
	Grid Devices tab	49
	Device State	49
	Registered Devices	50
	Activation Status	50
	Decommissioned Devices	50

Refresh	50
Configure	50
Elipsis (...)	51
Search	51
Display Columns	52
Export to CSV	52
Check Box	52
Devices column headings	53
Configuring a Device	54
Apply Template	54
Create Template	55
Configure	55
Additional Info	60
User Access	60
SNMP Credentials	61
iDRAC Settings	62
Backup Settings	64
Restore Backup	66
Revisions	67
Upgrade Settings	67
Change Password	68
Power Actions	69
Activation and Reset	70
Grid Templates tab	71
Refresh	71
Add Template	72
Duplicate Template	72
Delete Template	72
Elipsis (...)	72
Search	73
Display Columns	73
Export to CSV	73
Check Box	74
Devices column headings	74
Adding a template	75
User Management	76
Add User	76
Edit User	77
Delete User	77
Search	77
Download	77
Check Box	78
User Management Column Headings	79
Settings	79
Change Password	80
About	81
Log Out	81
Backup and restore	82
Creating a backup	82
Restoring a backup	83
Configuring network settings by command script	83
Using LiveWire with Omnippeek	84
Integrated Remote Access Controller (iDRAC)	85
iDRAC and network security	85
Setting the IP address for iDRAC	85
Access BIOS setting to configure IP address	85
Connecting to iDRAC on LiveWire	85

	Changing the default password	87
	Accessing a remote console	88
	Reimaging LiveWire with an ISO image	89
	Rebooting LiveWire	92
	Starting / Shutting down LiveWire	92
	Accessing the iDRAC interface over the USB port	93
Chapter 3	Sending LiveFlow Telemetry	96
	About sending telemetry to LiveNX and other platforms	97
	Configuring LiveFlow telemetry	97
	General	98
	Adapter	101
	Hardware Profiles	102
	LiveFlow	107
	Filters	114
	Recommendations for better performance at higher data rates	114
	An example of using LiveWire, LiveNX, and Omnipeek	115
Chapter 4	Creating and Managing API Tokens	119
	About API Tokens	120
	Creating an API Token	120
	Managing API Tokens	122
Chapter 5	Configuring Access Control	124
	About Access Control	125
	Enabling Access Control	125
	About Roles	129
	Configuring Roles	129
	Policy Descriptions	131
	Configuring Filters for Roles	132
	Manage Users for Roles	134
	Manage Groups for Roles	135
	Manage Sessions for Roles	137
	Adding a Role	138
	Enabling Third-Party Authentication	139
	When Upgrading From LiveWire v23.3.1 or Earlier	145
Chapter 6	Capture Adapters for LiveWire	147
	About capture adapters	148
	1G capture adapter	148
	1G capture adapter I/O bracket	148
	LED status	149
	10G capture adapter	149
	10G capture adapter (2-port) I/O bracket	150
	10G capture adapter (4-port) I/O bracket	150
	LED status	150
	40G capture adapter	151
	40G capture adapter I/O bracket	151
	LED status	151
	100G capture adapter	152
	100G capture adapter I/O bracket	152
	LED status	153
	Enabling PTP support for capture adapters	153
	Configuration parameters	154
	Synchronizing the capture engine clock	155
	Connecting the external time synchronization adapter	156

	Troubleshooting the capture adapters.....	156
	Verifying link status	156
Chapter 7	Network Port Requirements	158
	LiveWire/Omnipeek Port Information	159
	NetFlow (NetFlow v5, NetFlow v9, and IPFix) (optional).....	159
	iDRAC (out-of-band LiveWire management) Default Port Requirements ...	159
Chapter 8	Hardware Specifications	160
	LiveWire technical specifications.....	161
	LiveWire Edge	161
	LiveWire Core	162
	LiveWire PowerCore	163
	LiveWire StorageCore	164
	Capture adapter technical specifications.....	164
	1G capture adapter specifications	164
	10G capture adapter (2-port) specifications	166
	10G capture adapter (4-port) specifications	166
	40G capture adapter specifications	167
	100G capture adapter specifications	167

Introduction

In this chapter:

- About LiveWire* 2
- What's included* 3
- Front / rear panels* 4
- Inside the appliance* 11
- Installing LiveWire*16
- Connecting TeraVault to LiveWire PowerCore*19
- LiveWire Activation* 22
- Starting / shutting down LiveWire*30
- Contacting LiveAction support*30

About LiveWire

Congratulations on your purchase of LiveWire™! LiveWire appliances uniquely combine flow-based reporting using deep packet inspection (DPI) with high-speed, packet capture and storage. LiveWire is designed to work with LiveAction's LiveNX and various other platforms. Because LiveWire starts with packet data, it is able to provide a unique, and extended, set of flow-based monitoring data called LiveFlow. LiveFlow is extended IPFIX data and is exported to LiveNX and other platforms. See Chapter 3, [Sending LiveFlow Telemetry](#) for the additional tasks you must perform in order to export LiveFlow data from LiveWire. Please also refer to the LiveNX and the other platform documentation for more information on using the LiveFlow data exported to LiveNX and other platforms.

LiveWire is available in the following configurations:

	LiveWire Edge	LiveWire Core	LiveWire PowerCore	LiveWire StorageCore
Chassis	Mini Network Appliance	1U	2U	4U 60-Bay high-density storage server chassis
Processor	Intel® Atom® C3758	AMD® 1x7313	AMD® 2x EPYC 73F3	(2) Intel Xeon Gold 6326
Base Frequency	2.2 GHz	3.0 GHz	3.5 GHz	2.9 GHz
Cores	8	16	12	16
Threads		32	24	32
Memory	16 GB	64 GB	256 GB	192 GB
Expansion Slots	N/A	1 x 16 full-height PCI Express 3.0 slot NOTE: A total of one capture adapter can be added to the LiveWire Core.	Eight available PCI Express 3.0 slots NOTE: A total of three high speed capture adapters can be added to the LiveWire PowerCore.	Four available PCI Express 3.0 slots to support up to three high speed capture adapters
Integrated Network Interfaces	<ul style="list-style-type: none"> • Mini-USB console port • Management port • Three Ethernet ports • Two bridge ports 	4 x 1GBASE-T iDRAC	4 x 1GBASE-T iDRAC	2x10G Base-T ports
Storage-OS	Included as part of Storage-Data	Included as part of Storage-Data	Two 2 TB SSD SAS ISE drives for OS	Two 960 GB SSD drives for OS
Storage-Data	1 TB SSD	Available with 32 TB SAS ISE storage, RAID 0 with optional RAID 10	200 TB SAS storage, RAID 6 (240 TB, optional RAID 0) NOTE: Optional external storage with LiveWire TeraVault — Up to 800 TB, RAID 6 (960 TB, optional RAID 0) of additional storage (4x 2U TeraVaults)	1.4 PB SAS storage, RAID 6 or optional RAID 0

	LiveWire Edge	LiveWire Core	LiveWire PowerCore	LiveWire StorageCore
Capture Adapter Options (High performance network analysis cards)	N/A	1G Capture Adapter (4-port) NOTE: A total of one capture adapter can be added to the LiveWire Core.	1G Capture Adapter (4-port) 10G Capture Adapter (2- or 4-port) 40G Capture Adapter (2-port) 100G Capture Adapter (2-port) NOTE: A total of three capture adapters can be added to the LiveWire PowerCore.	1G Capture Adapter (4-port) 10G Capture Adapter (2- or 4-port) 40G Capture Adapter (2-port) 100G Capture Adapter (2-port) NOTE: A total of three capture adapters can be added to the LiveWire StorageCore
Additional			PERC H840 Adapter (used only for storage subsystem)	Internal RAID on StorageCore is Broadcom 9670-24i

Note In this guide, references to 'LiveWire' refer to the complete collection of LiveWire configurations described in the table above. When necessary, references to a specific LiveWire configuration are specified to note any differences between configurations.

What's included

Your standard LiveWire package includes:

LiveWire Edge:

- LiveWire Edge packet capture and analysis appliance
- Pre-loaded, tested, and fully integrated LiveWire software for high-speed packet capture, storage, and flow based telemetry generation
- Web-based configuration
- LiveWire Omnipeek
- Omnipeek for Windows License (1)
- AC power adapter and cord
- Rubber feet (4)
- Ethernet cable
- Mini-USB console cable

LiveWire Core/Power:

- LiveWire packet capture and analysis appliance
- Pre-loaded, tested, and fully integrated LiveWire software for high-speed packet capture, storage, and flow based telemetry generation
- Web-based configuration
- LiveWire Omnipeek
- Omnipeek for Windows License (1)
- Two power cords
- Rack-mount rails
- Chassis bezel

LiveWire StorageCore:

- LiveWire packet capture and analysis appliance

- Pre-loaded, tested, and fully integrated LiveWire software for high-speed packet capture, storage, and flow based telemetry generation
- Web-based configuration
- LiveWire Omnipeek
- Omnipeek for Windows License (l)
- Two power cords
- Rack-mount rails
- Chassis bezel

Front / rear panels

See the illustrations and descriptions of the front and back panel of LiveWire in the sections below.

LiveWire Edge front panel



Item	Indicator, Button, or Connector	Description
1	Reset Button	Insert a paper clip, and press and hold the reset button for three seconds to reset LiveWire Edge to its factory settings. You will lose all saved settings and data on LiveWire Edge when it is reset to its factory settings. Once LiveWire Edge has reset, you will need to run the configuration utility again as described in 'Using the LiveAdmin utility' on page 32.
2	Power-on Button with LED	Press to power-on or power-off LiveWire Edge. When in Standby mode, the LED lights red; in Power-on mode, the LED lights green; when Off, the LED does not light.
3	Power-in Socket	Connects to the screw-on connector on the power adapter included with LiveWire Edge.

Note: Make sure the screw-on connector on the power adapter is connected to the Power-in Socket on LiveWire Edge before the power adapter is plugged into an AC power source.

LiveWire Edge rear panel

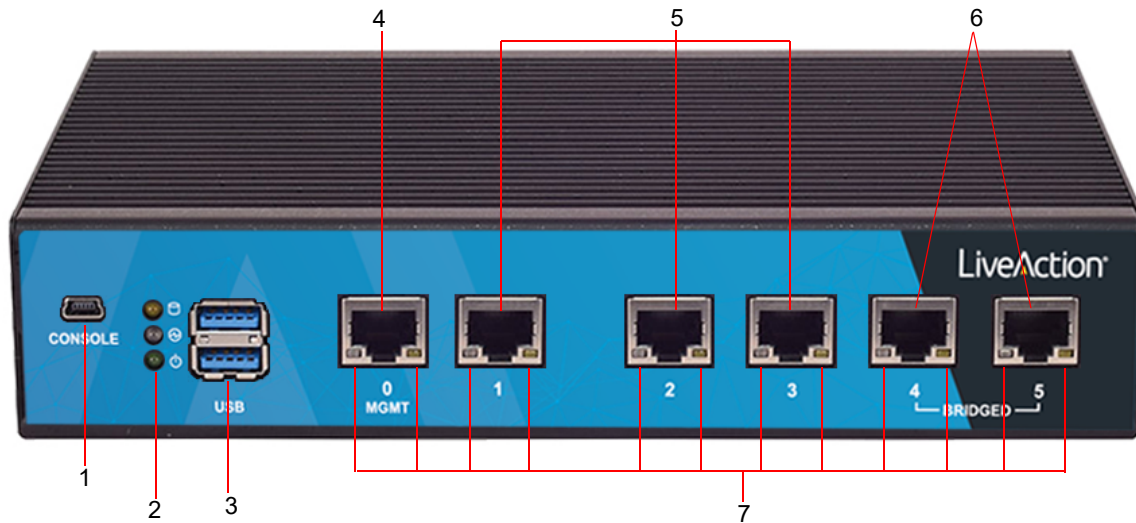

Item	Indicator, Button, or Connector	Description
1	Mini-USB Port	The Mini-USB port (console port) lets you connect to another computer terminal for advanced diagnostics or recovery access using a mini-USB console cable connected from the USB port on your PC/laptop to the Mini-USB Port on the rear panel of LiveWire Edge. See 'Connect to LiveWire Edge via the Mini-USB port' on page 17.
2	Storage/Status/Power LEDs	Storage: If the LED blinks, it indicates data access activities; otherwise, it remains off. Status: When LiveWire Edge is first powered on, the LED momentarily blinks green, and then remains off. Power: If the LED is on it indicates that the system is powered on. If it is off, it indicates that the system is powered off.
3	USB 3.0 Ports	The USB ports are reserved for future expansion.
4	'MGMT' Port	This 1GbE Ethernet port is the management port that lets you configure LiveWire Edge (see 'Using the LiveAdmin utility' on page 32). Connect a standard Ethernet cable from your network to the 'MGMT' port.
5	'1-3' Ports	These 1GbE Ethernet ports are used for capturing packets from your network. Connect a standard Ethernet cable from your network to the desired port on LiveWire Edge.

Item	Indicator, Button, or Connector	Description
6	'4-5 Bridged'	<p>These 1GbE Ethernet ports are configured as a bridge and are used when you want to insert LiveWire Edge in-line between two network devices. This configuration allows the capture of traffic flowing between the two network nodes without requiring a tap. In this implementation, packets enter LiveWire Edge through one of the bridge ports, and then exit LiveWire Edge through the remaining bridge port. Essentially, any traffic that gets to one bridge port is copied to the other bridge port. In cases where power is turned off or is lost to LiveWire Edge, the two bridge ports are connected as if they are a wire ('fail to wire'), so Internet connectivity is not lost.</p> <p>To establish the bridge, connect standard Ethernet cables so that LiveWire Edge is between your cable modem (Internet connection) and the LAN. One of the bridge ports on LiveWire Edge is connected to the cable modem, while the other bridge port is connected to the LAN. Both bridge ports must be connected in this fashion in order to properly establish the bridge.</p> <p>Do not connect each of the bridge ports to the same IP routed network; otherwise, a routing loop is created, and can cause the network to be inoperable.</p> <p>Note: When powering the LiveWire Edge on or off, there will be a short network disruption when the hardware bypass (bridge port) is enabled or disabled.</p>
7	Port LEDs	The two LEDs on the bottom of the Ethernet ports light to indicate activity. A green and yellow LED light to indicate a connection has been established. A flashing yellow LED indicates data access activities.

LiveWire Core front panel

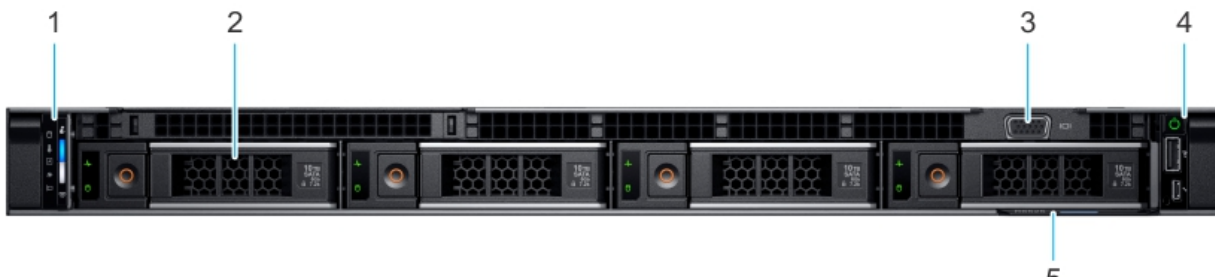

Item	Ports, Panels, or Slots	Description
1	Left control panel	Contains system health and system ID, status LED, and optional iDRAC Quick Sync 2 (wireless) LED.
2	Hard drive (4)	3.5 inch hot-swappable hard drive/SSD.
3	VGA port	Enables you to connect a display device to the system.
4	Right control panel	Contains the power button, USB port, iDRAC Direct micro port, and the iDRAC Direct status LED.
5	Information tag	The Information tag is a slide-out label panel that contains system information such as Service Tag, NIC, MAC address, and so on.

Note To access the front panel, the front bezel must be removed.

LiveWire Core back panel

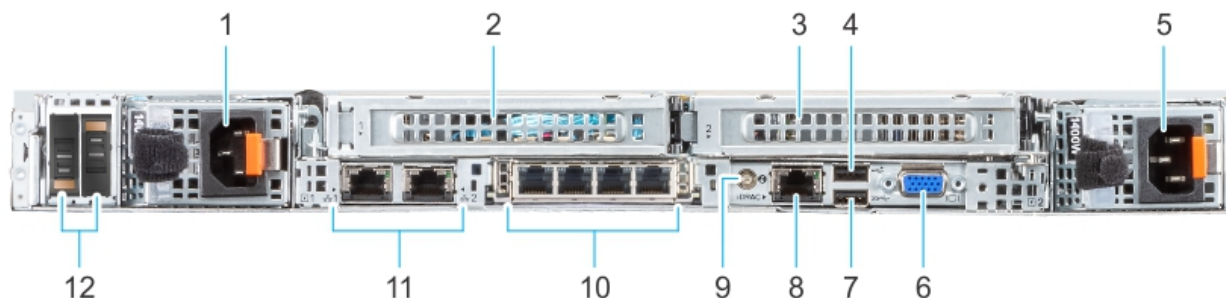

Item	Ports, Panels, or Slots	Description
1	Power supply unit (PSU 1)	AC 800 W. Both power supplies should be plugged in to power to provide redundancy.
2	PCIe expansion card riser (slot 1)	The expansion card riser enables you to connect PCI Express expansion cards. The capture adapter is installed in this PCIe expansion card riser, specifically slot 1 for x16.
3	PCIe expansion card riser (slot 2)	The expansion card riser enables you to connect PCI Express expansion cards.
4	USB 2.0 port (1)	Use the USB 2.0 port to connect USB devices to the system. These ports are 4-pin, USB 2.0-compliant.
5	Power supply unit (PSU 2)	AC 800 W. Both power supplies should be plugged in to power to provide redundancy.
6	VGA port	Use the VGA port to connect a display to the system.
7	USB 3.0 port (1)	Use the USB 3.0 port to connect USB devices to the system. These ports are 4-pin, USB 3.0-compliant.
8	iDRAC dedicated port	This port enables you to remotely access iDRAC. iDRAC is very useful for remote management and direct access of the appliance.
9	System identification button	The System Identification (ID) button is available on the back of the system. Press the button to identify a system in a rack by turning on the system ID button. You can also use the system ID button to reset iDRAC and to access BIOS using the step through mode.
10	OCP NIC port (optional)	This port supports OCP 3.0. The NIC ports are integrated on the OCP card which is connected to the system board.
11	NIC port (2)	The NIC ports are embedded on the LOM card that is connected to the system board.
12	BOSS S2 card (optional)	This slot supports the BOSS S2 module.

LiveWire PowerCore front panel

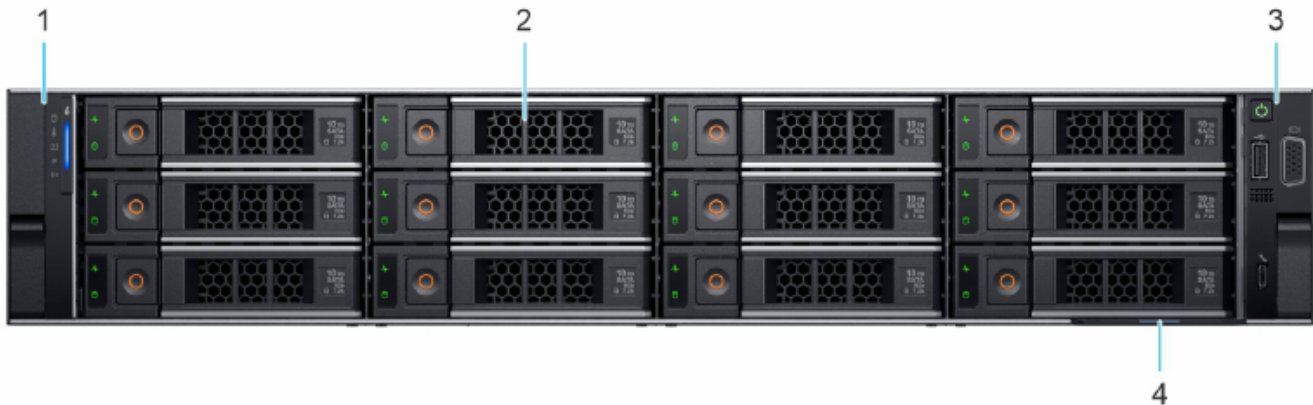

Item	Indicator, Button, or Connector	Description
1	Left control panel	Contains system health and system ID, status LED, and iDRAC Quick Sync 2 (wireless) LED.
2	Drive (12)	3.5 inch hot-swappable hard drive (12)
3	Right control panel	Contains the power button, VGA port, USB 2.0 port, and iDRAC Direct micro USB port.
4	Information tag	The information tag is a slide-out label panel that contains system information such as service tag, NIC, MAC address, and so on.

Note To access the front panel, the front bezel must be removed.

LiveWire PowerCore back panel

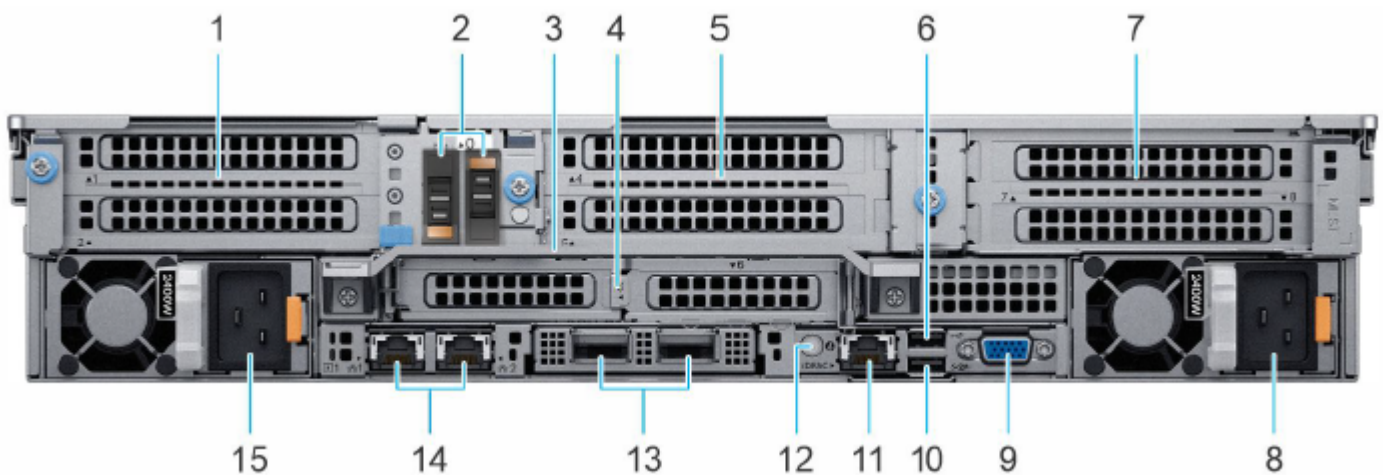

Item	Ports, Panels, or Slots	Description
1	PCIe expansion card riser 1 (slot 1 and slot 2)	The expansion card riser enables you to connect PCI Express expansion cards.
2	BOSS S2 card (optional)	This slot supports the BOSS S2 module.

Item	Ports, Panels, or Slots	Description
3	Rear handle	To lift the system.
4	PCIe expansion card riser 2 (slot 3 and slot 6)	The expansion card riser enables you to connect PCI Express expansion cards.
5	PCIe expansion card riser 3 (slot 4 and slot 5)	The expansion card riser enables you to connect PCI Express expansion cards.
6	USB 2.0 port (1)	This port is USB 2.0-compliant.
7	PCIe expansion card riser 4 (slot 7 and slot 8)	The expansion card riser enables you to connect PCI Express expansion cards.
8	Power supply unit (PSU 2)	AC 1100 W Both power supplies should be plugged in to power to provide redundancy.
9	VGA port	Enables you to connect a display device to the system.
10	USB 3.0 port (1)	The USB ports are 9-pin and 3.0-compliant. These ports enable you to connect USB devices to the system.
11	iDRAC dedicated port.	This port enables you to remotely access iDRAC. iDRAC is used for remote management and direct access to the appliance.
12	System identification button	The System Identification (ID) button is available on the back of the system. Press the button to identify a system in a rack by turning on the system ID button. You can also use the system ID button to reset iDRAC and to access BIOS using the step through mode.
13	OCP NIC port (optional)	This port supports OCP 3.0. The NIC ports are integrated on the OCP card which is connected to the system board.
14	NIC port (1, 2)	The NIC ports are embedded on the LOM card that is connected to the system board. The left-most NIC port is Ethernet Port 0 (Eth 0), and the right-most NIC port is Ethernet Port 1 (Eth 1).
15	Power supply unit (PSU 1)	AC 1100 W Both power supplies should be plugged in to power to provide redundancy.

LiveWire StorageCore front panel

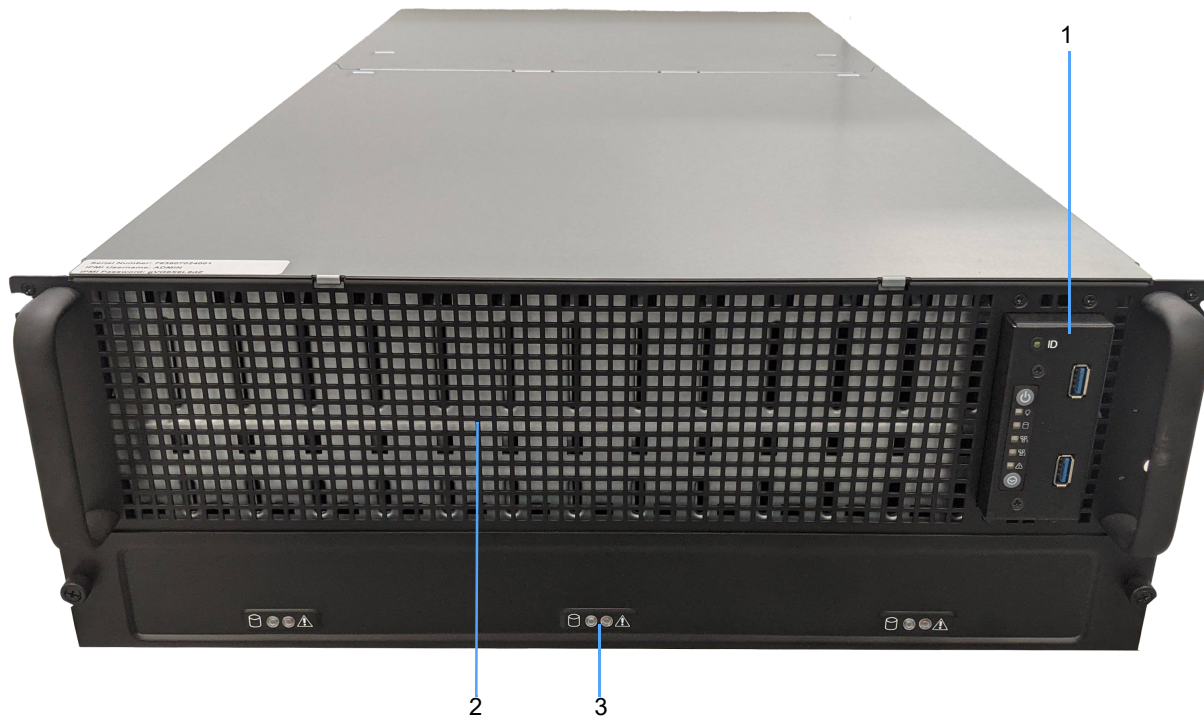

Item	Indicator, Button, or Connector	Description
1	Right control panel	Contains the power button, System status LEDs, network interface LEDs, and USB ports
2	Drive (60)	3.5 inch hot-swappable hard drive (60)
3	RAID status LEDs (3)	Provides RAID status

LiveWire StorageCore back panel

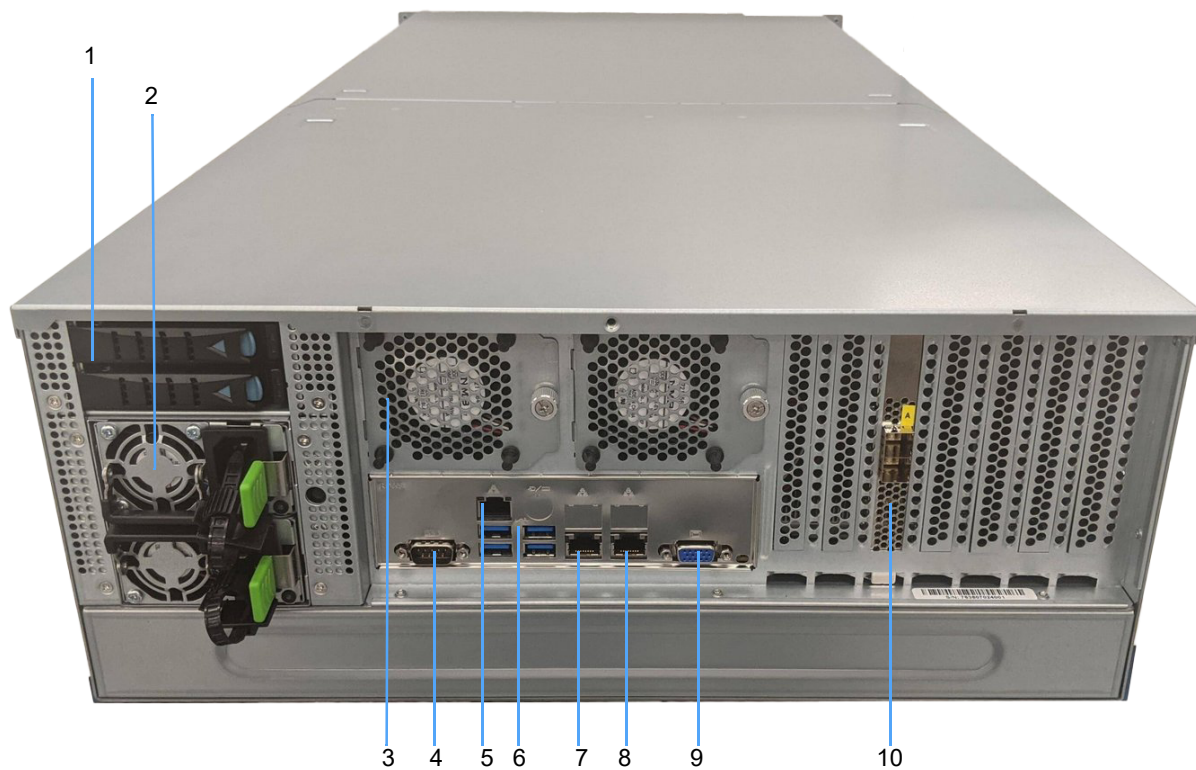

Item	Ports, Panels, or Slots	Description
1	OS Hard Drives (2)	960 GB SSD drives for OS
2	Power supply units (2)	AC 1600 W (two units) Both power supplies should be plugged in to power to provide redundancy.
3	Cooling fans (2)	Dual cooling fans
4	Serial port	Connect a male DB9 serial cable to this port.
5	Virtual port	
6	USB 2.0 port (4)	These ports are USB 2.0-compliant.
7	NIC port 1	Ethernet Port 0 (Eth 0)
8	NIC port 2	Ethernet Port 1 (Eth 1)
9	VGA port	Enables you to connect a display device to the system.
10	Capture adapter	High-speed capture adapter resides in this slot.

Inside the appliance

CAUTION! Many repairs may only be done by a certified service technician. You should only perform troubleshooting and simple repairs as directed by the LiveAction support team. Damage due to servicing that is not authorized by LiveAction is not covered by your warranty. Read and follow the safety instructions that are shipped with your product.

LiveWire Core internal components

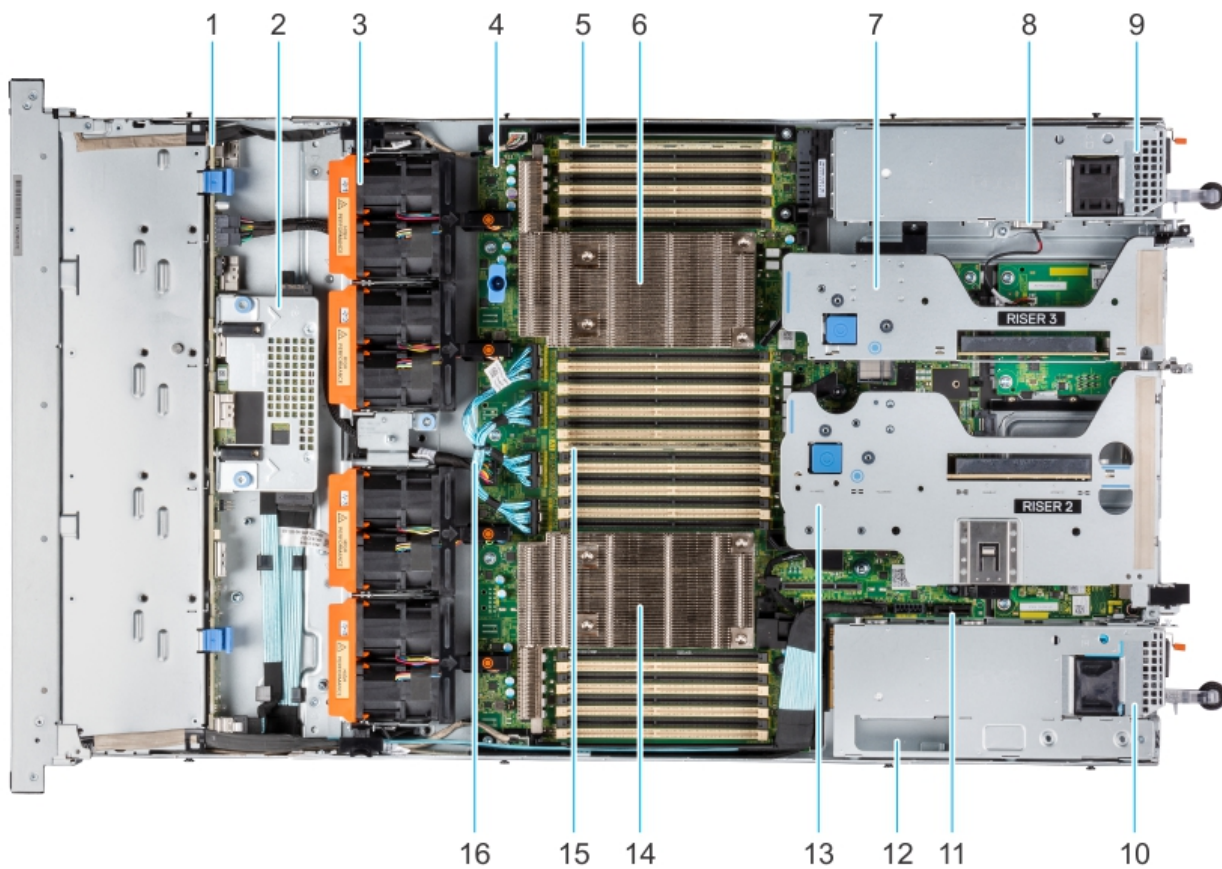

Item	Description
1	Drive backplane
2	Rear mounting front PERC module
3	Dual fan module (4)
4	System board
5	Memory DIMM socket for processor 2 (B1)
6	Heat sink for processor 2
7	Riser 3
8	Intrusion switch
9	Power supply unit (PSU 2)
10	Power supply unit (PSU 1)
11	IDSDM/Internal USB card port
12	BOSS slot
13	Riser 2
14	Heat sink for processor 1
15	Memory DIMM socket for processor 1 (B1)
16	Memory DIMM socket for processor 1 (B2)

Item	Description
15	Memory DIMM socket for processor 1 (A1)
16	xGMI cables

Note A defective drive should have a consistent RED blinking LED which should make it easier to detect.

LiveWire PowerCore internal components

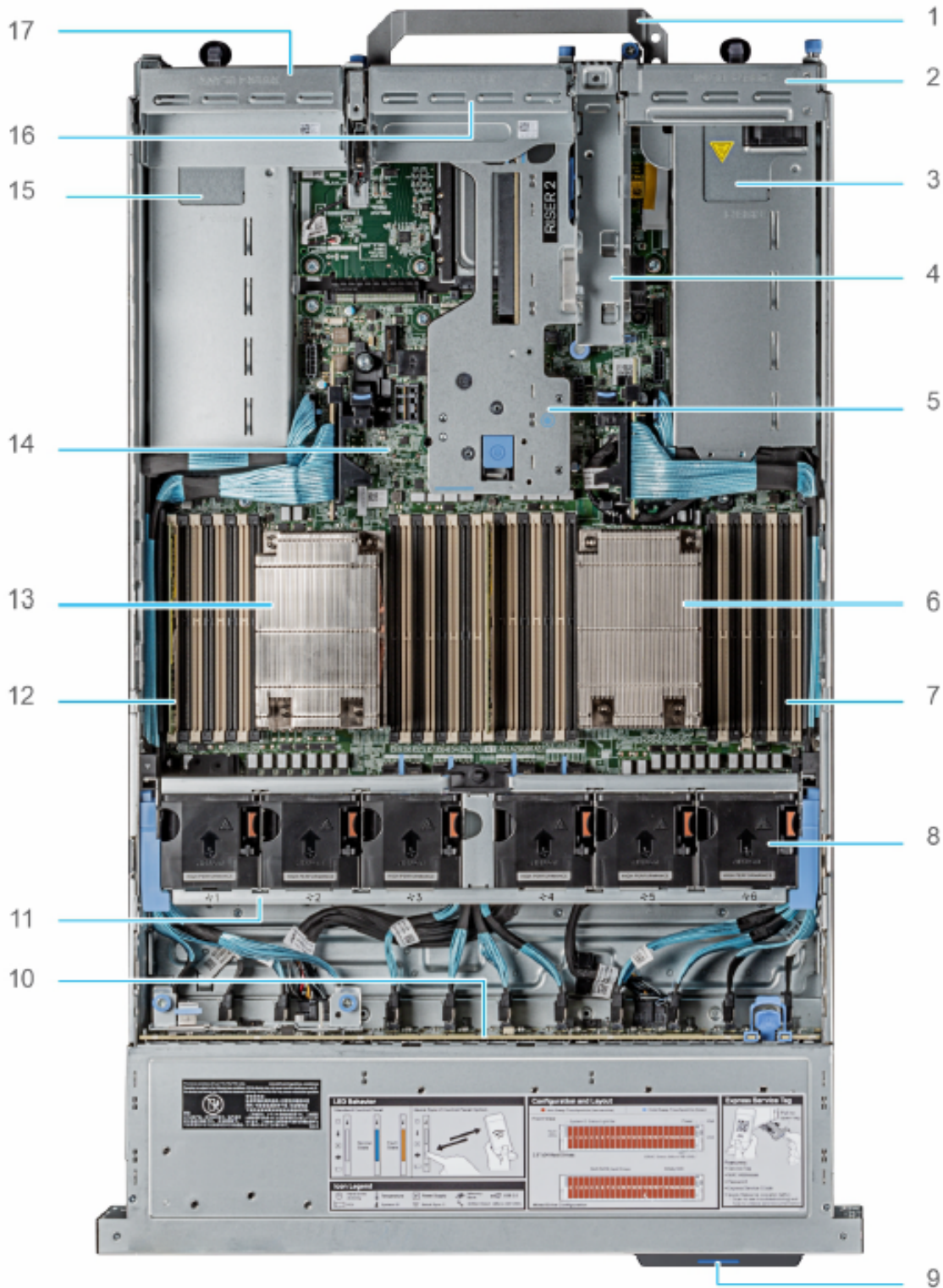

Item	Description
1	Handle
2	Riser 1 blank
3	Power supply unit (PSU 1)
4	BOSS S2 card slot
5	Riser 2
6	Heat sink for processor 1
7	Memory DIMM socket for processor 1 (E,F,G,H)
8	Cooling fan assembly
9	Service tag
10	Drive backplane
11	Cooling fan cage assembly
12	Memory DIMM socket for processor 2 (A,B,C,D)
13	Heat sink for processor 2
14	System board
15	Power supply unit (PSU 2)
16	Riser 3 blank
17	Riser 4 blank

Note A defective drive should have a consistent RED blinking LED which should make it easier to detect.

LiveWire StorageCore internal components

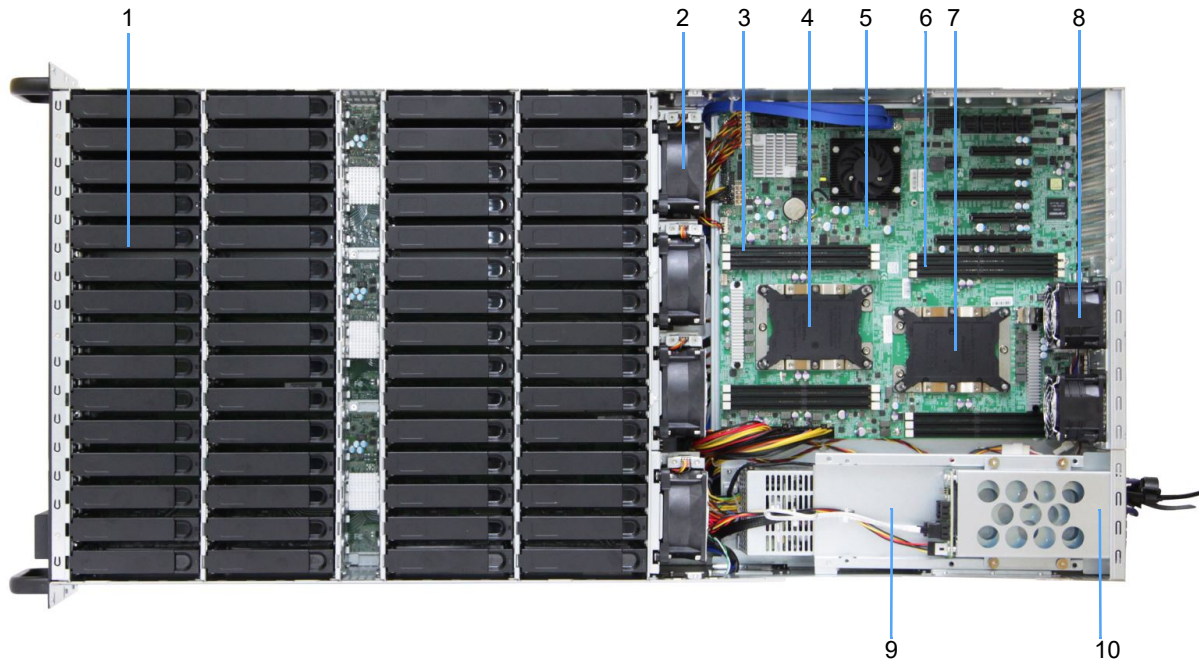

Item	Description
1	Hard drives (60)
2	Drive cooling fans (4)
3	Memory DIMM socket for processor 2 (6)
4	Processor 2
5	System board
6	Memory DIMM socket for processor 1 (6)
7	Processor 1
8	System cooling fans (2)
9	Power supply units (2)
10	Hard drive bay for OS drives

Installing LiveWire

See the instructions below for installing your LiveWire appliance.

LiveWire Edge

To install LiveWire Edge:

1. Attach the rubber feet to the bottom of LiveWire Edge and place LiveWire Edge on a flat surface.
2. Attach the power adapter by screwing in the connector on the adapter to the power-in socket on the back panel.
3. Plug the other end of the power adapter into a reliable power source.

CAUTION! Do not place anything on top of or directly next to LiveWire Edge. Any obstructions to the heat sink located on top of LiveWire Edge can cause the unit to overheat.

4. Connect LiveWire Edge to the network to capture traffic:
 - From the Bridge ports: To use the Bridge ports, connect LiveWire Edge inline on a network segment. In this mode, connect the eth 4 port to the side of the network with the upstream router; and connect eth 5 to the LAN side of the network.
 - From the Span ports: To use the span ports, connect LiveWire Edge directly to a span port from a switch or router.
5. To configure and use the LiveWire Edge, connect the 'MGMT' port to the network.

Connect to LiveWire Edge via the Mini-USB port

The Mini-USB port (Console port) on LiveWire Edge lets you connect to another computer terminal for advanced diagnostics or recovery access using a mini-USB console cable (included with LiveWire Edge) connected from the USB port on your PC/laptop to the Mini-USB Port of LiveWire Edge.

Using the Mini-USB port on LiveWire Edge, a laptop, and a terminal program of your choice, you can log into LiveWire Edge and access the LiveWire command prompt (admin@livewire).

To connect to LiveWire Edge:

1. Connect the mini-USB console cable from your laptop to the Mini-USB port on LiveWire Edge.
2. Navigate to the Windows Device Manager and determine the COM port assigned to the Mini-USB port on LiveWire Edge:
 - a. Open the Windows Device Manager.
 - b. In the "Ports (COM & LPT)" category, find the matching COM Port #. For example, "COM4" in "Prolific PL2303GC USB Serial COM Port (COM4)."
3. Using any serial terminal program (e.g., HyperTerminal or Putty), establish a connection to LiveWire Edge using the COM Port # identified above. Make sure the appropriate terminal settings match the settings below for LiveWire Edge.
 - Connection Type: [Serial]
 - Serial line: [COM#] (see Step 2 above)
 - Terminal Type: [VT100+]
 - Bits per second: [115200]
 - Data Bits: [8]
 - Parity: [None]
 - Stop Bits: [1]
 - Flow Control: [None]
 - VT-UTF8 Combo Key Support: [Enabled]
 - Recorder Mode: [Disabled]
 - Resolution 100x31: [Enabled]
4. Once a connection to LiveWire Edge has been established, the LiveWire Edge configuration menu appears.

With each configuration change, you are prompted to enter your admin password. The default username and password is:

username: *admin*

password: *admin*

LiveWire Core/PowerCore/StorageCore



LiveWire Core



LiveWire PowerCore



LiveWire StorageCore

To install LiveWire Core/PowerCore/StorageCore:

1. Place LiveWire Core/PowerCore/StorageCore on a flat surface, or mount it in a standard 19-inch equipment rack.
2. Connect a power cable to each of the two power outlets at back of the unit.

Note LiveWire Core/PowerCore/StorageCore has two redundant high-efficiency “hot-swappable” power supplies. If a power module fails, it should be replaced immediately. If your LiveWire Core/PowerCore/StorageCore is under warranty, please contact Technical Support to arrange for a replacement power supply.

3. Plug the other end of the power cables to an AC outlet.

Important! WARNING: This device has more than one power cord. Disconnect ALL power supply cords before servicing.

AVERTISSEMENT: Cet appareil a plus d'un cordon d'alimentation. Débranchez TOUTES les cordons d'alimentation avant l'entretien.

Connecting network cables

LiveWire Core/PowerCore includes Gigabit Ethernet ports and Integrated Remote Access Controller (iDRAC) ports used for remotely accessing and troubleshooting LiveWire Core/PowerCore. LiveWire Edge includes Gigabit Ethernet ports, but no iDRAC port. See 'Front / rear panels' on page 4 for the location of these ports. For information on using iDRAC, see 'Integrated Remote Access Controller (iDRAC)' on page 85.

To connect network cables:

- Use a standard Ethernet cable to connect these ports to your network.

Tip To reach LiveWire through an SSH connection, you can use an Ethernet cable connected directly between the Gigabit Ethernet port on LiveWire and your PC or laptop. LiveWire eth0 port is configured at the factory to have a DHCP IP address with a fail over to 192.168.1.21. The PC or laptop must be configured to be on the same IP subnet.

System fans

LiveWire Core/PowerCore/StorageCore has multiple cooling fans that are used to cool the system chassis. If any one of the fans fail, it should be replaced immediately. If your LiveWire Core/PowerCore/StorageCore is under warranty, please contact LiveAction Technical Support to arrange for a replacement fan.

Note LiveWire Edge has no fan or any other moving parts.

Important! The chassis top cover must be properly installed in order for the cooling air to circulate correctly through the chassis and cool the components.

Important! WARNING: Slide/rail mounted equipment is not to be used as a shelf or a work space.

AVERTISSEMENT: Le matériel monté sur rails/coulisseaux ne doit pas être utilisé comme étagère ou espace de travail.

Connecting TeraVault to LiveWire PowerCore

The storage capacity of any LiveWire PowerCore with 200 TB, RAID 6 (240 TB, optional RAID 0) of total hard disk capacity can be increased through the addition of TeraVault for LiveWire PowerCore. TeraVault is available in a configuration of 200 TB, RAID 6 (240 TB, optional RAID 0). Up to four TeraVault units can be added for a total of up to 1000 TB, RAID 6 (1200 TB, optional RAID 0). If you purchased TeraVault with your LiveWire PowerCore, the instructions to connect it to your LiveWire PowerCore are provided below.

To connect TeraVault to LiveWire PowerCore:

1. Make sure both TeraVault and LiveWire PowerCore are powered OFF.
2. Select a suitable location for both TeraVault and LiveWire PowerCore. Both units can be installed on a flat surface, or mounted in a standard 19-inch equipment rack.
3. Run the SAS external cascading cable between the units so that the cable is not kinked, bent, or twisted. The SAS external cascading cable is included with TeraVault.

Note If you have multiple TeraVault boxes, and the system is disconnected for any reason, the cabling of the boxes needs to be exactly as it was before, otherwise the RAID won't be seen correctly. To assist you with the cabling, every TeraVault box is labeled with a number, and every TeraVault cable is labeled to the exact port it needs to get plugged into. See 'Connecting multiple TeraVault units' on page 21.

4. Facing the rear of LiveWire PowerCore, insert one connector of the SAS external cascading cable into the left RAID port (SAS Port 0) of the RAID controller on LiveWire PowerCore so that the release pull-tab is on the top.

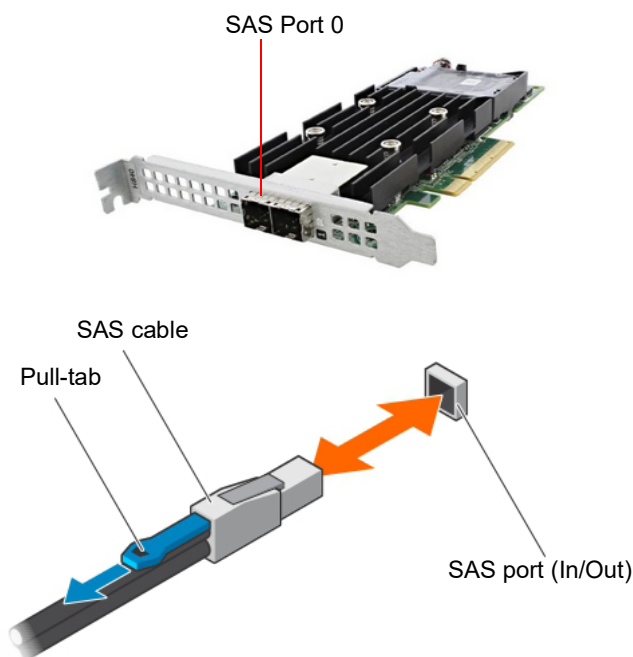

Note It may be necessary to remove the handle on the rear of the appliance in order to connect the SAS external cascading cable into the left RAID port of the RAID controller.

5. Facing the rear of TeraVault, insert the other end of the SAS external cascading cable into the RAID port (Port 0) of the RAID controller on TeraVault so that the release pull-tab is on the top.

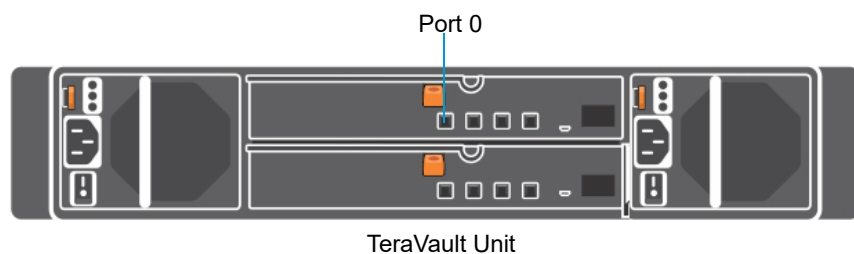

Note Be certain the connectors are installed completely as it can look and feel as if the cable is secured without actually making a connection. Give the connector body a tug, then push it in again to be sure.

6. Turn on power to TeraVault by pressing the power button on the front of the chassis. You may see brief bursts of LED activity as the expander in TeraVault scans the drives.
7. Turn on the power to LiveWire PowerCore. The system is ready for use as soon as the LiveWire PowerCore boot sequence completes.

Connecting multiple TeraVault units

When connecting multiple TeraVault (JBOD) units to LiveWire PowerCore, it is important to note that each LiveWire PowerCore and TeraVault unit have LiveAction labels with matching serial numbers. Additionally, each TeraVault unit has a label on the front (designating JBOD 1, 2, 3, etc.), which is the order the units are daisy-chained to LiveWire PowerCore and each of the TeraVault units. Multiple SAS external cascading cables are included and are also labeled to guide you in connecting each of the units.

To connect multiple TeraVault units:

1. Locate the LiveAction label on each LiveWire PowerCore and TeraVault unit. Make sure the LiveAction serial numbers are the same on LiveWire PowerCore and each of the storage units.
2. Locate the first TeraVault unit labeled as 'JBOD 1' and also the SAS external cascading cable labeled 'HBA - Port 0.' Use the 'HBA Port 0' cable and connect the TeraVault unit 'JBOD 1' to LiveWire PowerCore as described in 'Connecting TeraVault to LiveWire PowerCore' on page 19. Make sure the release pull-tab on the cable is on top.
3. Locate the second TeraVault unit labeled as 'JBOD 2' and also the SAS external cascading cable labeled 'JBOD 1 - Port 1.' Use the 'JBOD 1 - Port 1' cable and connect this TeraVault unit to the previous TeraVault unit (JBOD 1). Make sure the release pull-tab on the cable is on top.
4. Repeat Step 3 for any additional TeraVault units, making sure each successive 'JBOD' is connected to the previous 'JBOD' using the appropriate SAS external cascading cable.

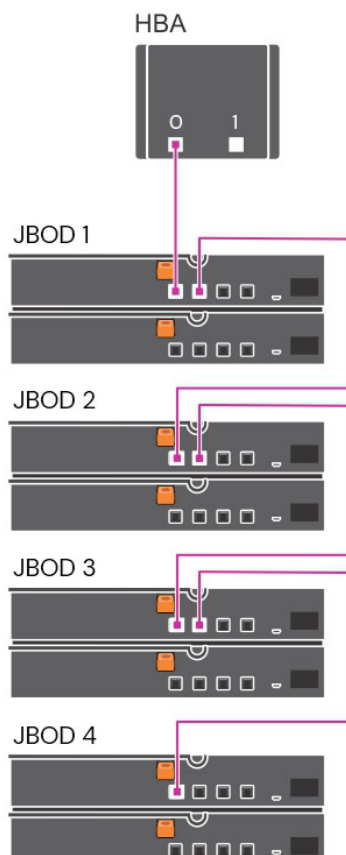

LiveWire Activation

Once LiveWire is installed, when you attempt to connect to it for the very first time, you must activate the product before it can be used. You can activate LiveWire either from logging directly into a web-based version of Omnipeek, or from the **Capture Engines Window** in Omnipeek.

Both an automatic and a manual method are available for activation. The automatic method is quick and useful if you have Internet access from the computer from where you are performing the activation. If Internet access is not available, the manual method is available; however, you will need to go to a computer that does have Internet access in order to download a License file that is required to complete the manual activation.

You will need to enter the following information to successfully activate LiveWire, so please have this information readily available:

- IP address of LiveWire
- Product key
- User name
- Company name
- Email address
- Version number

Activation via Omnipeek Web

Note Activation via the web-based version of Omnipeek is not supported on an Internet Explorer web browser. Please use any web browser other than Internet Explorer to activate LiveWire via Omnipeek.

To activate LiveWire via Omnipeek:

1. From your web browser, type the IP address of LiveWire into the URL field of the browser and press **Enter**. The Omnipeek login screen appears.

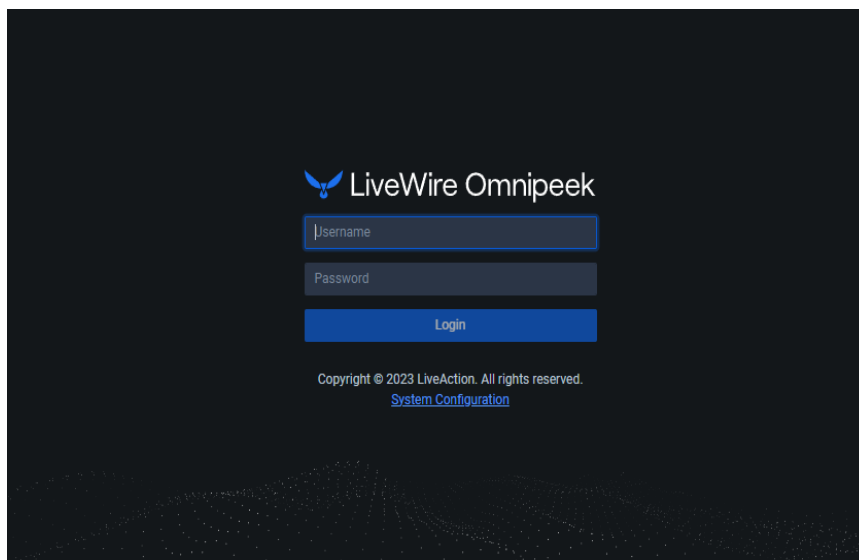

- **Username:** Type the username for LiveWire. The default is *admin*.
 - **Password:** Type the password for LiveWire. The default is *admin*.
2. Type the *Username* and *Password* and click **Login**. The Omnipeek *Activation License* window appears.

Note You can also access the Omnipeek *Activation License* window by clicking *Update License* from the Capture Engine *Home* screen in Omnipeek.

3. If your client has an active Internet connection, select *Automatic* and click **Next**. The **Customer Information** window appears. Continue with Step 4 below.

- *NAME*: Type the user name of the customer.
- *COMPANY*: Type the company name.
- *EMAIL*: Type the email address of the customer.
- *PRODUCT KEY*: Type the product key.

If your client does not have an active Internet connection, or you are prevented from accessing the Internet using personal firewalls, or there are other network restrictions that may block automatic activations, select *Manual* and click **Next**. The **Manual Activation** window appears. Skip to Step 5 below.

Note The manual activation method is available for instances described above; however, you will need to go to a computer that does have Internet access in order to download a License file that is required to complete the manual activation.

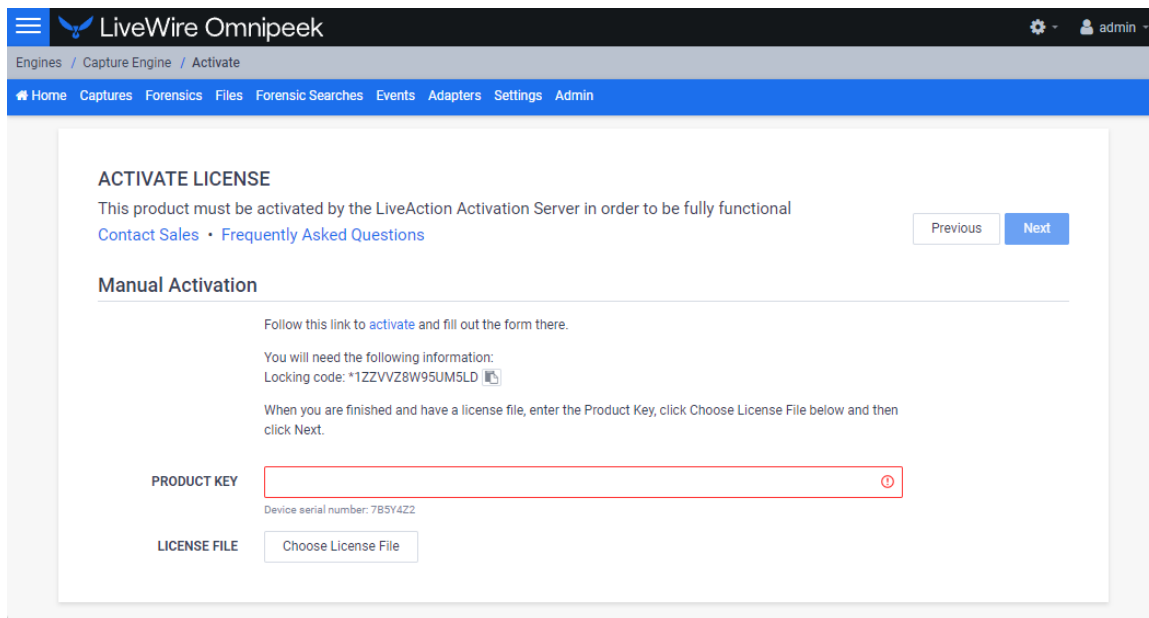

Note The *Locking code* displayed in the window above is required in Step 6 below. You can click the small icon next to the code to save it to the clipboard so you can paste it into the Locking Code field in Step 6 below.

4. Complete the Customer Information window and click **Next**. LiveWire is now activated and you can begin using the product. The activation process is complete.

Note If the automatic activation does not complete successfully, go back and select the manual activation process. Personal firewalls or other network restrictions may block automatic activations.

5. Click the *activate* link (https://mypeek.liveaction.com/activate_product.php) in the window. A web browser page opens that allows you to activate your LiveAction product and to obtain and download a license file. The license file is required to complete the manual activation.

Activate Your LiveAction Product

Use this form to activate LiveAction software in instances where the machine you are installing on doesn't have an internet connection.

PLEASE NOTE: This form is only used to activate version 12.0 and later of our Omnipeek and Capture Engine products. If you have a version previous to 12.0, please go to <https://reg.savvius.com> to manually activate your product.

Version:	<input type="text" value="--"/> . <input type="text" value="--"/>	Enter only two numbers, e.g. for 3.0.1, enter 3.0.
Product Key or Serial Number :	<input type="text"/>	
Locking Code:	<input type="text"/>	During installation of your product, this value will be displayed on your screen. Please enter it exactly as shown.
First Name:	<input type="text"/>	
Last Name:	<input type="text"/>	
Email Address:	<input type="text"/>	
Company:	<input type="text"/>	
<input type="button" value="ACTIVATE PRODUCT ▶"/>		

- Complete the information on the activation page and click **ACTIVATE PRODUCT**. The following page appears once the activation is complete.

MYPEEK PRODUCT PORTAL / ACTIVATE PRODUCT

ACTIVATE PRODUCT

Activate Your LiveAction Product

✔ Your activation is complete, please download your license file below.

- Click **DOWNLOAD LICENSE FILE** to save the license file to your computer. You will need the license file in the following steps.
- Return back to the to the **Manual Activation** window, and click **Choose License File**.
- Navigate to the license file downloaded above and click **Open**.
- Click **Next** in the **Manual Activation** window. LiveWire is now activated and you can begin using the product. The activation process is complete.

Activation via Omnipeek

Note Activation of LiveWire via Omnipeek is supported on Omnipeek version 13.1 or higher.

To activate LiveWire via Omnipeek:

1. From the Omnipeek Start Page, click **View Capture Engines** to display the **Capture Engines** window.

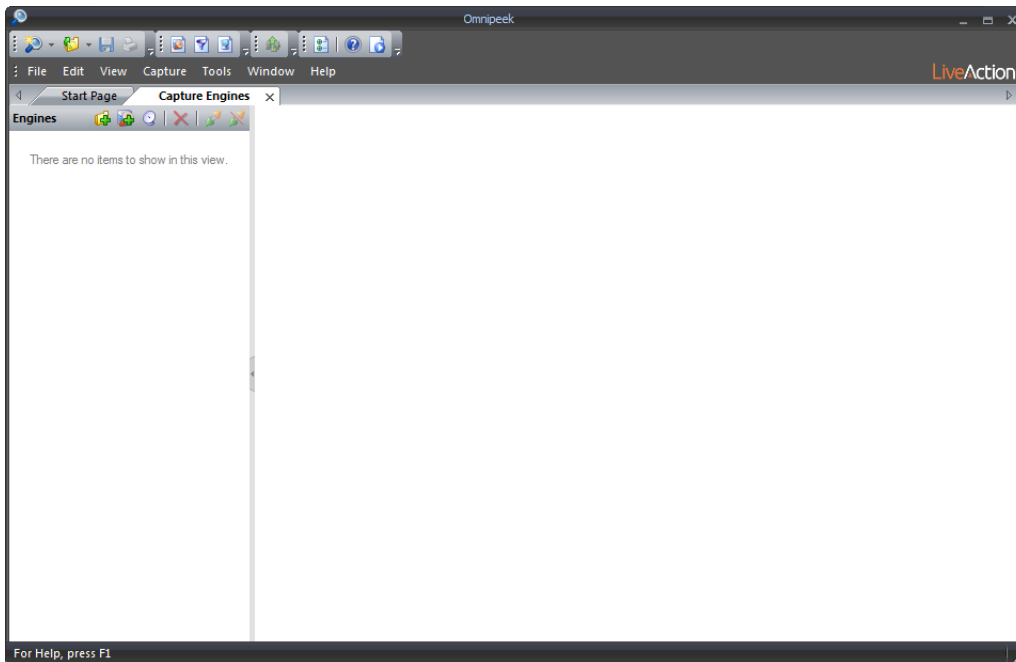

2. Click *Insert Engine* and complete the **Insert Engine** dialog.

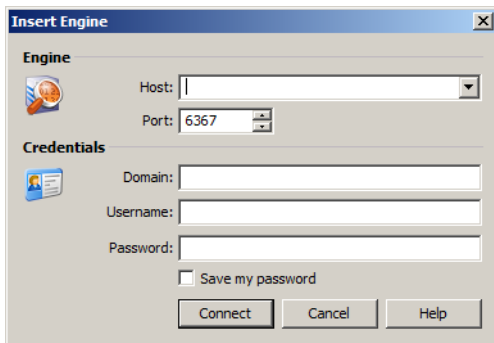

- *Host*: Enter the IP address of LiveWire.
 - *Port*: Enter the TCP/IP port used for communications. Port 6367 is the default for LiveWire.
 - *Domain*: Type the Domain for login to LiveWire. If LiveWire is not a member of any Domain, leave this field blank.
 - *Username*: Type the username for LiveWire. The default is *admin*.
 - *Password*: Type the password for LiveWire. The default is *admin*.
 - *Save my password*: Select this option to remember your password to connect to LiveWire.
3. Click **Connect** to connect to LiveWire. If LiveWire has not yet been activated, the activation message appears in the **Capture Engines** window.

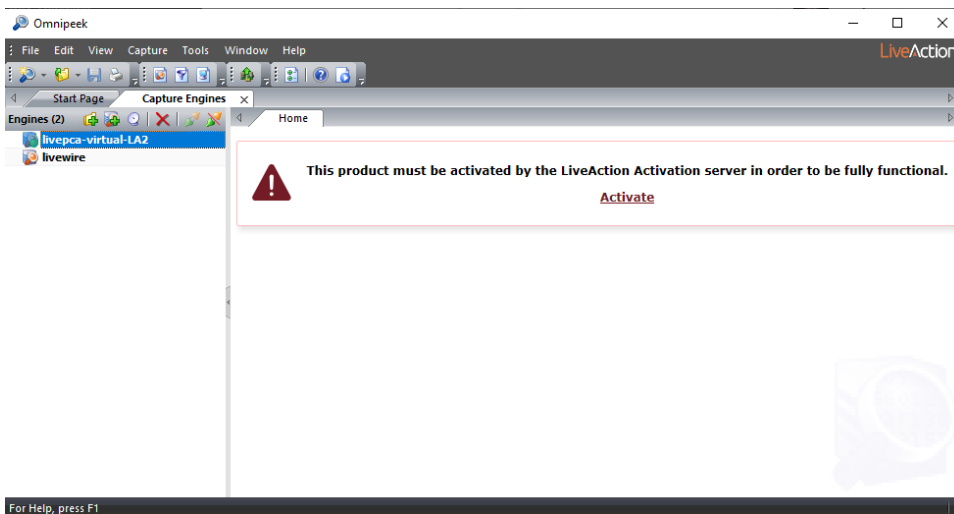

4. Click **Activate** LiveWire. The **Activation Method** dialog appears.

 A screenshot of the 'Product Activation' dialog box. The title bar is 'Product Activation'. The main heading is 'Activation Method' with the instruction 'Choose Automatic or Manual Activation'. Below this, a message states: 'This product must be activated by the LiveAction Activation server in order to be fully functional. For more information, go to [Frequently Asked Questions](#).' There are two radio button options: 'Automatic: requires an Internet connection' (which is selected) and 'Manual: generates your license via a web page'. At the bottom, there are three buttons: '< Back', 'Next >', and 'Cancel'.

5. If your client has an active Internet connection, select *Automatic* and click **Next**. Otherwise, select *Manual* and click **Next**. The **Customer Information** dialog appears.

 A screenshot of the 'Product Activation' dialog box, showing the 'Customer Information' tab. The title bar is 'Product Activation'. The main heading is 'Customer Information' with the instruction 'Enter the following information'. Below this, it says 'Please enter the following'. There are four text input fields: 'User Name:', 'Company Name:', 'Email:', and 'Serial Number or Product Key:'. At the bottom, there are three buttons: '< Back', 'Next >', and 'Cancel'.

- *User Name*: Type the user name of the customer.
- *Company Name*: Type the company name.

- *Email*: Type the email address of the customer.
 - *Serial Number or Product Key*: Type either the serial number or product key.
6. Complete the **Customer Information** dialog and click **Next**. If you selected the *Automatic* activation, LiveWire is now activated and you can begin using the product. The activation process is complete.

If you selected the *Manual* activation, the **Manual Activation** dialog appears. You will need to continue with the remaining steps.

Note The manual activation method is available for instances when a computer does not have Internet access; however, you will need to go to a computer that does have Internet access in order to download a License file that is required to complete the manual activation.

Product Activation

Manual Activation
Follow the directions below

Go to [activate product](#) and fill out the "Activate Product" form located there. When you are finished and have a license file, click Next.

You will need the following information:

Product Name: LiveCapture Virtual
Product Version: 13.1
Serial Number or Product Key:
XL0902RZ6RZ35YB
Locking Code:
*1J3ZER83TBKVZRH

< Back Next > Cancel

Note The *Product Key*, and also the *Locking Code* displayed in the **Manual Activation** dialog are required in the next step. You can cut and paste this information from the **Manual Activation** dialog when required in the next step.

7. Click the *activate product* link (https://mypeek.liveaction.com/activate_product.php) in the dialog. A web browser page opens that allows you to activate your LiveAction product and to obtain and download a license file. The license file is required to complete the manual activation.

Activate Your LiveAction Product

Use this form to activate LiveAction software in instances where the machine you are installing on doesn't have an internet connection.

PLEASE NOTE: This form is only used to activate version 12.0 and later of our OmnipEEK and Capture Engine products. If you have a version previous to 12.0, please go to <https://reg.savvius.com> to manually activate your product.

Version:	<input type="text" value="--"/> . <input type="text" value="--"/>	Enter only two numbers, e.g. for 3.0.1, enter 3.0.
Product Key or Serial Number :	<input type="text"/>	
Locking Code:	<input type="text"/>	During installation of your product, this value will be displayed on your screen. Please enter it exactly as shown.
First Name:	<input type="text"/>	
Last Name:	<input type="text"/>	
Email Address:	<input type="text"/>	
Company:	<input type="text"/>	
<input type="button" value="ACTIVATE PRODUCT ▶"/>		

- Complete the information on the activation page and click **ACTIVATE PRODUCT**. The following page appears once the activation is complete.

MYPEEK PRODUCT PORTAL / ACTIVATE PRODUCT

ACTIVATE PRODUCT

Activate Your LiveAction Product

✔
Your activation is complete, please download your license file below.

- Click **DOWNLOAD LICENSE FILE** to save the license file to your computer. You will need the license file in Step 11 below.
- Return to the **Omnipeek Product Activation** dialog, and click **Next**. The **Manual Activation/Choose the license file** dialog appears.

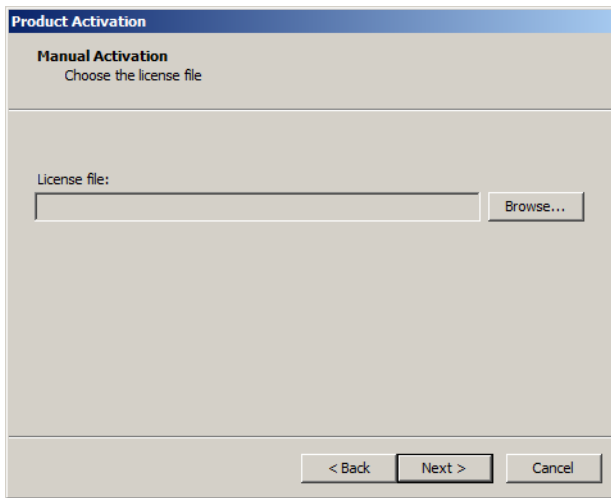

11. Browse to the license file that was downloaded above and click **Next**. LiveWire is now activated and you can begin using the product. The activation process is complete.

Starting / shutting down LiveWire

To start LiveWire:

- LiveWire Edge: Press the power-on button on the back panel of LiveWire Edge.
- LiveWire Core/PowerCore: Press the power button in the upper right corner on the front of the chassis.

To shutdown LiveWire:

- LiveWire Edge: Press the power-on button briefly on the back panel of LiveWire Edge.
- Click the actions link at the top of the configuration utility to display the Actions dialog, and then select Power Off option.
- SSH, or use a console connection to LiveWire and use the 'shutdown' command from the command prompt (*admin@livewire*):

```
shutdown -h now
```

Note You can also use the iDRAC interface to shutdown and start LiveWire Core/PowerCore. See 'Starting / Shutting down LiveWire' on page 92.

Attaching the front bezel

To attach the front bezel (LiveWire Core/PowerCore only):

- Attach the front bezel by inserting the locking hooks into the front chassis of LiveWire. The bezel should be centered between the two black tabs on the left and right of the LiveWire chassis.

Contacting LiveAction support

Please contact LiveAction support at <https://www.liveaction.com/support/technical-support/> if you have any questions about the installation and use of LiveWire.

An RMA (Return Material Authorization) number must be obtained from LiveAction before returning hardware. Please contact LiveAction technical support at <https://www.liveaction.com/support/technical-support/> for instructions.

Configuring LiveWire

In this chapter:

<i>Logging-in to LiveWire command line</i>	32
<i>Using the LiveAdmin utility</i>	32
<i>Using Grid to manage and configure LiveAction appliances</i>	47
<i>Configuring network settings by command script</i>	83
<i>Using LiveWire with Omnippeek</i>	84
<i>Integrated Remote Access Controller (iDRAC)</i>	85

Logging-in to LiveWire command line

You can log into the LiveWire command line in one of five ways:

- Remotely, using remote SSH software such as *Putty*
- Remotely, using the Integrated Remote Access Controller (iDRAC) firmware and hardware built into LiveWire. See 'Integrated Remote Access Controller (iDRAC)' on page 85. (LiveWire Core/PowerCore only)
- Locally, by connecting a monitor, mouse and keyboard to LiveWire (LiveWire Core/PowerCore only)
- Locally, by using a mini-USB console cable (included with LiveWire Edge) connected from the USB port on your PC/laptop to the Mini-USB Port of LiveWire Edge. See 'Connect to LiveWire Edge via the Mini-USB port' on page 17. (LiveWire Edge only)
- Locally, by using a micro-AB interface cable for iDRAC management (LiveWire Core/PowerCore only). See 'Accessing the iDRAC interface over the USB port' on page 93.

The first time you log into LiveWire, use the following as your username and password:

username: *admin*

password: *admin*

After you have logged into LiveWire for the first time, you can then change your password and add users and privileges.

Note For security reasons, we strongly recommend changing the default password.

Using the LiveAdmin utility

The LiveAdmin utility on LiveWire lets you view and configure a variety of settings from the LiveAdmin views in the left-hand navigation pane of the utility. To learn more about each of the LiveAdmin views, go to the appropriate section below:

The screenshot displays the LiveAdmin Dashboard. At the top right, the date and time are 2023-11-02 19:55:45 GMT -07:00, and the user is Administrator. The left sidebar contains navigation options: DASHBOARD, AUTHENTICATION, MONITOR, NETWORK, OMNI, SUPPORT, REMOTE SYSLOG, TIME, TLS, and UPDATE. The main content area is titled 'Dashboard' and is divided into three sections:

- Version Information:** Shows LiveAdmin version 23.3.0-4e6a072 and LivePCA version 23.4.0-5-v1.
- Network Details:** Shows details for interface eth0, including Mode (Static), Hostname (liveaction), IP address (10.8.100.141), Netmask (255.255.255.0), Gateway (10.8.100.1), and DNS Servers (10.4.155.19, 8.8.8.8).
- Service Details:** Includes a Refresh button and a table of running services.

Service	CPU	Memory	PID	Commands
ntp	0.0 %	0.0 %	3215	[Start] [Stop] [Refresh]
omnid	0.0 %	1.0 %	2094762	[Start] [Stop] [Refresh]
snmpd	0.0 %	0.0 %	3067	[Start] [Stop] [Refresh]

- **Dashboard:** The *Dashboard* view provides you with some very basic information about the system. See 'Dashboard' on page 34.
- **Authentication:** The *Authentication* view lets you change the password for LiveWire. See 'Authentication' on page 35.

- *Monitor*: The *Monitor* view displays the health of the overall system. See 'Monitor' on page 36.
- *Network*: The *Network* view lets you configure the primary network interfaces network settings and the hostname of the system. See 'Network' on page 37.
- *Omni*: The *Omni* view lets you configure *Centralized Management, Factory Reset, Backup, Restore, SFTP,* and *SNMP* for the appliance. See 'Omni' on page 39.
- *Support*: The *Support* view lets you download logs from the system that would be helpful in troubleshooting issues. See 'Support' on page 44.
- *Remote Syslog*: The *Remote Syslog* view lets you configure a remote syslog server that receives all system logs. See 'Remote Syslog' on page 45.
- *Time*: The *Time* view lets you configure the system's Timezone and NTP servers. See 'Time' on page 45.
- *TLS*: The *TLS* view lets you change the self-signed certificates that LiveAdmin and Omnippeek use for HTTPS. See 'TLS' on page 46.
- *Update*: The *Update* view lets you update the appliance using a software update package. See 'Update' on page 46.
- *Administrator*: The *Administrator* context menu in the upper right lets you restart LiveWire, power off LiveWire or log out from the LiveAdmin utility. See 'Restart and power off' on page 47.

Important! LiveWire comes pre-configured to obtain its IP address via DHCP. The IP address is required to configure LiveWire, as described below. You can obtain the IP address by logging into Grid as described in 'Using Grid to manage and configure LiveAction appliances' on page 47.

Note If an IP address is not assigned to LiveWire by the DHCP server within two minutes of being connected to the network, LiveWire defaults to a static address of 192.168.1.21.

Login

To log into the LiveAdmin utility:

1. LiveWire Core/PowerCore: Connect LiveWire Core/PowerCore to your network router or switch with an Ethernet cable.

LiveWire Edge: Connect the '0 MGMT' port on LiveWire Edge to your network router or switch with an Ethernet cable.

2. From a browser window on a computer connected to the same network as LiveWire, enter the IP address for LiveWire in the URL box as *<IP address>:8443* (e.g., 192.168.1.21:8443). The LiveAdmin Login screen appears.

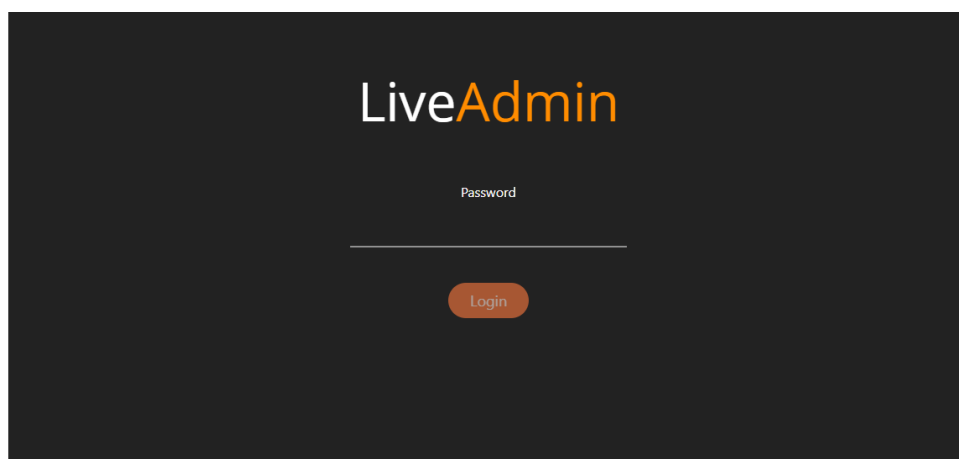

- Enter the default password 'admin' and click **Login**.

Note If you are using LiveWire Omnippeek, you can also access the LiveAdmin Login screen by clicking *System Configuration* from either the Omnippeek Login screen, or by clicking *Configure System* from within Omnippeek itself.

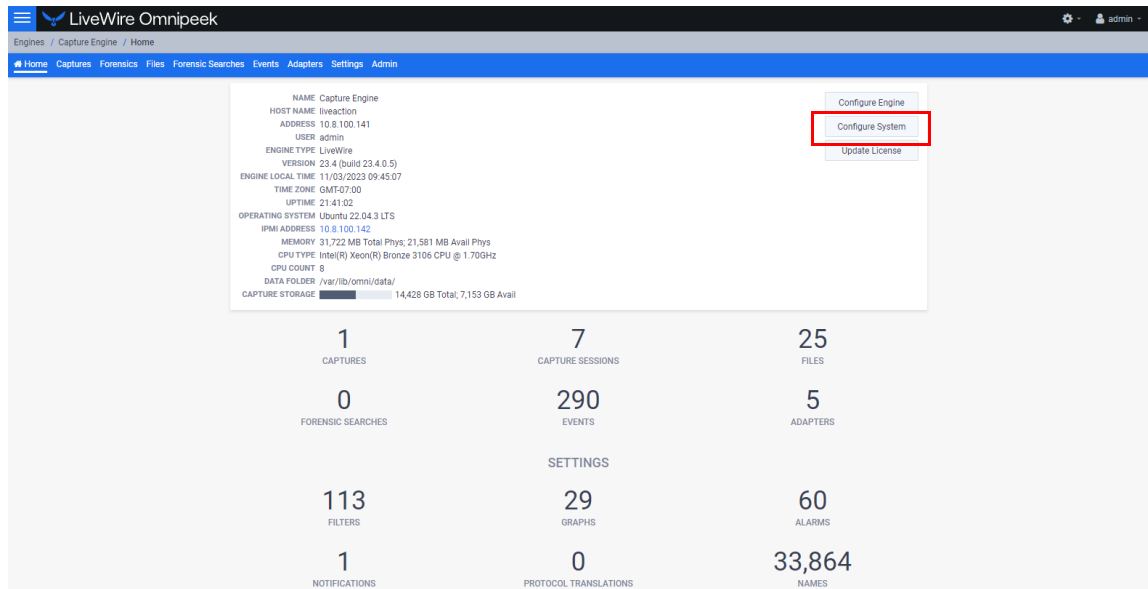
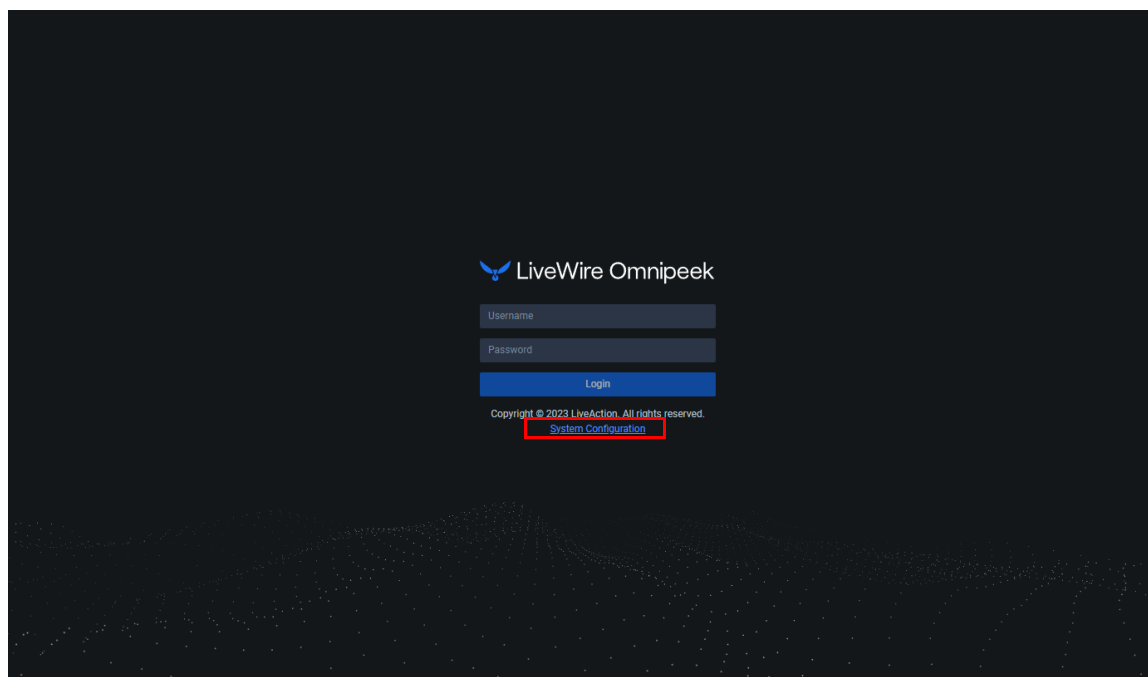

Dashboard

The *Dashboard* view provides you with some very basic information about the system.

The screenshot shows the LiveWire Dashboard interface. At the top right, it displays the date and time '2023-11-02 19:55:45 GMT -07:00' and the user 'Administrator'. The dashboard is divided into three main sections:

- Version Information:** A table showing the versions of LiveAdmin and LivePCA.

LiveAdmin	23.3.0-4e6a072
LivePCA	23.4.0-5-v1
- Network Details:** A table showing details for the 'Interface eth0'.

Mode	Static
Hostname	liveaction
IP address	10.8.100.141
Netmask	255.255.255.0
Gateway	10.8.100.1
DNS Servers	10.4.155.19 8.8.8.8
- Service Details:** A table listing services with their CPU and memory usage, PID, and control buttons. A 'Refresh' button is located above the table.

Service	CPU	Memory	PID	Commands
ntp	0.0 %	0.0 %	3215	Start Stop Restart
omnid	0.0 %	1.0 %	2094762	Start Stop Restart
snmpd	0.0 %	0.0 %	3067	Start Stop Restart

- **Version Information:** This section displays the version numbers of the LiveAdmin utility and the software on the LiveAction appliance.
 - **LiveAdmin:** Displays the version number of the LiveAdmin utility
 - **LivePCA:** Displays the version number of the software installed on the LiveAction appliance.
- **Network Details:** This section displays the management interface details and the system hostname. The management interface is defined from the Network view in LiveAdmin. See 'Network' on page 37.
- **Service Details:** This section lists a set of services you are able to monitor. This has currently been limited to the omnid process only, although additional services could easily be added:
 - **Refresh:** Click to update the view
 - **Service:** Displays the name of the service
 - **CPU:** Displays the amount of CPU the service is using
 - **Memory:** Displays the amount of memory the service is using
 - **PID:** Displays the Process ID of the service
 - **Commands:**
 - Start** - Click to start the service and can only be triggered if the service is stopped.
 - Stop** - Click to stop the service and can only be triggered if the service is running.
 - Restart** - Click to restart the service and can only be triggered if the service is running.

Authentication

The *Authentication* view lets you change the password for LiveWire.

The screenshot shows the 'Authentication' section of the LiveAdmin interface. The main heading is 'Authentication'. Below it is a form titled 'Change OS Admin Password'. The form contains the following elements:

- Password Requirements:**
 - Must have 5 different characters than the last password!
 - Must be at least 6 characters!
 - Must contain at least 1 number!
 - Must contain at least 1 uppercase character!
 - Must contain at least 1 lowercase character!
 - Must contain at least 1 special character!
- Current Password*:** Input field with placeholder text 'Current Password'.
- New Password*:** Input field with placeholder text 'New Password'.
- Confirm Password*:** Input field with placeholder text 'Confirm password'.
- Update:** A green button to submit the form.

- **Current Password:** Enter the current password for LiveWire. The default is *admin*.
- **New Password:** Enter the new password for LiveWire. The new password must meet the following requirements:
 - Must have 5 different characters than the last password.
 - Must be at least 6 characters.
 - Must contain at least 1 number
 - Must contain at least 1 uppercase character.
 - Must contain at least 1 lowercase character.
 - Must contain at least 1 special character.
- **Confirm Password:** Enter the new password to confirm the password.
- **Update:** Click to change the password.

Note Make sure to note the *Password* that you configure.

Monitor

The *Monitor* view displays the health of the overall system. The view is broken up into four usage charts and one interface statistics table.

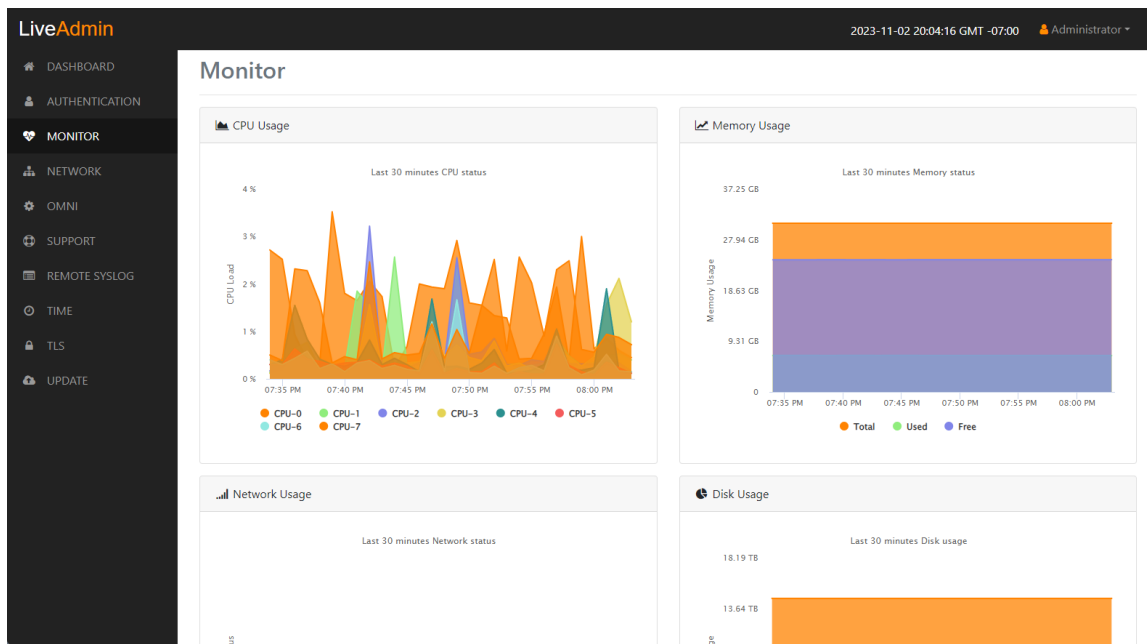

- **CPU Usage:** This chart displays the current usage of individual CPUs on the system. Click the CPU label in the legend to enable/disable its data displayed in the chart.
- **Memory Usage:** This chart displays the current amount of memory being consumed on the system. Click the *Total*, *Used*, or *Free* labels in the legend to enable/disable which data to display in the chart.
- **Network Usage:** This chart displays the current throughput of the network interfaces. Click the labels in the legend to enable/disable which data to display in the chart.
- **Disk Usage:** This chart displays the current amount of space being used by the Data and Metadata volumes. Click the *Total*, *Used*, or *Free* labels in the legend to enable/disable which data to display in the chart.
- **Interface Statistics:** This table displays the statistics of the primary management interface. To update the statistics click **Refresh**.

Network

The *Network* view lets you configure the primary network interface network settings and the hostname of the system. You can configure either DHCP or static network settings.

Note Changing the network settings will restart the omni service.

The screenshot shows the 'Network' configuration page in LiveAdmin. The interface includes a sidebar with navigation options like Dashboard, Authentication, Monitor, Network, Omni, Support, Remote Syslog, Time, TLS, and Update. The main content area is titled 'Network' and contains several input fields: Hostname* (liveaction), Network Mode* (Static), IP Address* (10.8.100.141), Netmask* (255.255.255.0), and Gateway* (10.8.100.1). Below these is a 'DNS' section with an 'Add DNS server' button and two existing servers: 10.4.155.19 and 8.8.8.8, each with a red 'X' delete icon. A green 'Submit' button is located at the bottom of the form.

- **Hostname:** Enter a name for LiveWire. A unique device name allows for easy identification of data sources. The hostname can only contain alphanumeric characters and hyphens, and cannot be longer than 255 characters.
- **Network Mode:** This setting lets you to specify whether LiveWire uses a DHCP or static setting for its IP address. If *Static* is selected, then *IP Address*, *Netmask*, *Gateway*, and *DNS* settings can be configured for LiveWire. If *DHCP* is selected, then LiveWire is configured by a DHCP server.

Important! LiveWire is pre-configured to obtain an IP address automatically from a DHCP server; however, we strongly recommend the use of a static IP address for LiveWire. If DHCP is selected as the *IP Assignment*, and if the address should change on a new DHCP lease, then the user must look up the new IP address assigned to LiveWire. To help you look up the IP address, the MAC Address of LiveWire is displayed as the *Ethernet Address*.

Note If *DHCP* is selected, you have approximately two minutes to connect LiveWire to your network in order for the DHCP server to assign an IP address. If an IP address is not assigned to LiveWire by the DHCP server within two minutes of being connected to the network, LiveWire defaults to a static address of 192.168.1.21. Please make sure LiveWire is connected to your network within the two minute time period from the time you click **Apply**. If you reboot LiveWire, the two minute clock is also reset.

- **IP Address:** This setting lets you specify the IP address that you are assigning to LiveWire.
- **Netmask:** A Netmask, combined with the IP address, defines the network associated with LiveWire.
- **Gateway.** Also known as 'Default Gateway.' When LiveWire does not have an IP route for the destination, the IP packet is sent to this address as it does not know how to direct it locally. Only a single default gateway can be defined.
- **DNS:** This is the domain name server. A Domain Name Server translates domain names (e.g., www.liveaction.com) into an IP address. To add a DNS server, enter the address of the server, and click the plus (+) icon. Multiple DNS name servers can be defined. You can also edit or delete any defined DNS servers.

Configure DHCP

To configure a DHCP IP address:

1. Enter a hostname in the *Hostname* field.
2. From the *Network Mode* list, select *DHCP*.
3. Click **Submit**.

Configure Static

To configure a static IP address:

1. Enter a hostname in the *Hostname* field.
2. From the *Network Mode* list, select *Static*.
3. Enter a valid IP address in the *IP Address* field.
4. Enter a valid netmask in the *Netmask* field.
5. Enter a valid default gateway in the *Gateway* field.
6. (Optional) Enter a valid DNS server in the *Add DNS server* field and click the plus (+) button.
7. Click **Submit**.

Note You will lose connection to LiveWire if you configured a new static address in *IP Address* above.

Omni

The *Omni* view lets you configure *Centralized Management*, *Factory Reset*, *Backup*, *Restore*, *SFTP*, and *SNMP* for the appliance.

The screenshot shows the LiveAdmin interface. On the left is a dark sidebar with the 'LiveAdmin' logo and a navigation menu including Dashboard, Authentication, Monitor, Network, **Omni**, Support, Remote Syslog, Time, TLS, and Update. The main content area is titled 'Omni' and features a 'Centralized Management Settings' section. This section includes a 'Centralized Management Settings' header, a paragraph explaining that centralized management is preferred for multiple appliances, and a checked checkbox for 'Enable Centralized Management'. Below this is an 'HTTP Proxy Configuration' section with input fields for Hostname (containing 'https // hostname'), Port (443), Username, Password, and Confirm Password. A green 'Apply' button is located at the bottom of the settings panel.

Centralized Management

Centralized management is the preferred way to manage and configure multiple LiveAction appliances. In order to enable centralized management select the *Centralized Management* check box and configure the *HTTP Proxy Configuration* settings. Once enabled, changes can still be made locally but configuration changes made in the centralized management console supersedes local changes. For instructions on how to register and manage devices from the centralized console please visit [MyPeek](#).

The screenshot shows the LiveAdmin interface with the 'Omni' section selected. On the left sidebar, 'OMNI' is highlighted. The main content area is titled 'Omni' and contains a 'Centralized Management' section. Under this section, there are options for 'Factory Reset', 'Backup', 'Restore', 'SFTP', and 'SNMP'. The 'Centralized Management Settings' panel is active, displaying a text block explaining centralized management and a checked checkbox labeled 'Enable Centralized Management'. Below this is the 'HTTP Proxy Configuration' section with input fields for Hostname, Port, Username, Password, and Confirm Password, and an 'Apply' button.

- *Enable Centralized Management.* Select this check box to enable Grid for LiveWire to manage and configure LiveWire from the cloud. See 'Using Grid to manage and configure LiveAction appliances' on page 47.

Note When Centralized Management is enabled, you can make local changes to LiveWire using the LiveAdmin utility; however, changes made with Grid will overwrite any local changes made with the LiveAdmin utility.

Factory reset

Factory reset allows you to reset the LiveAction software to factory defaults on LiveWire.

- *Factory Reset.* Click **Reset** to reset the LiveAction software.

CAUTION! All data captured by the LiveAction software will be deleted. All configuration settings will revert to their factory defaults, including the IP address of the management port.

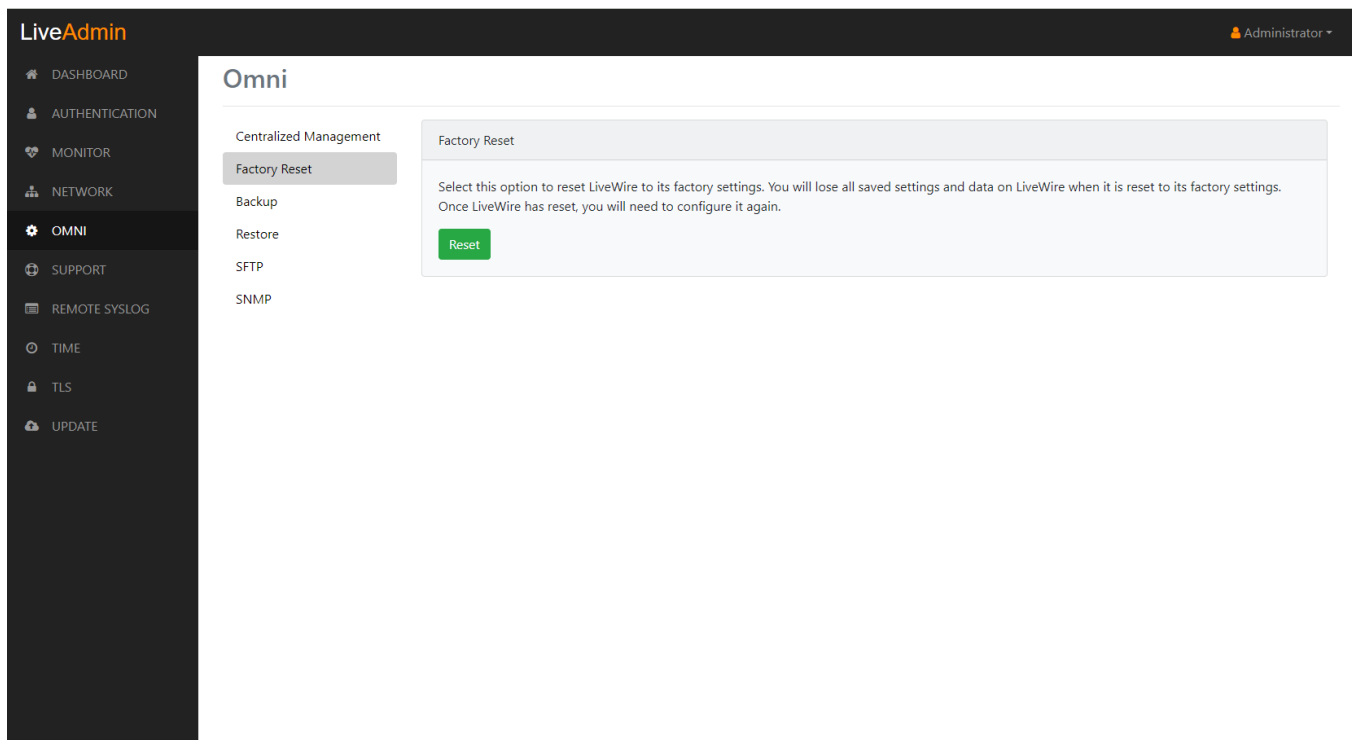

Backup

Backup allows you to back up all the system data on LiveWire to a back up file that you can restore at a later time.

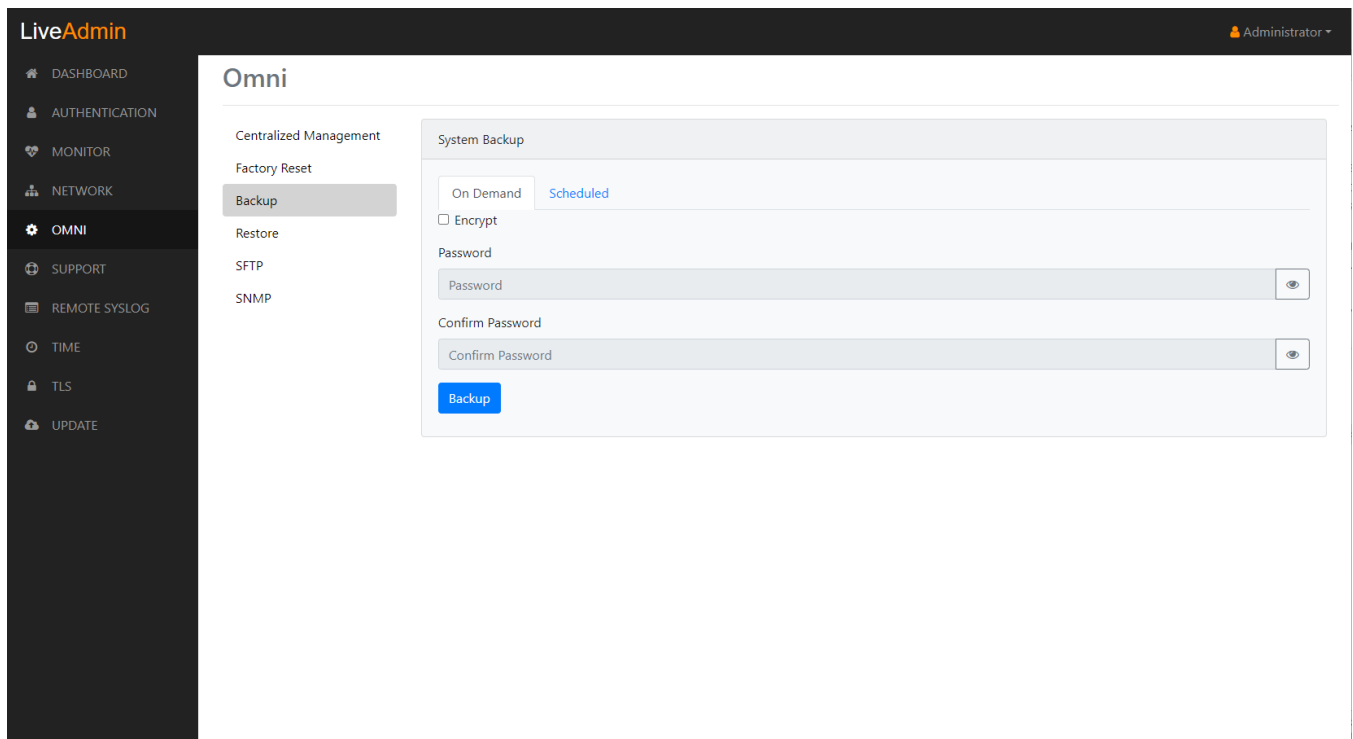

On Demand

- *Encrypt*: Select this data to encrypt the system backup. You will need to enter a password that is required to restore the backup to LiveWire.
- *Password*: Type a password for the backup.

- *Confirm Password*: Type the password again to confirm the password.
- *Backup*: Click to start the backup.

Scheduled

- *Backup Type*: Select either an *SFTP* or *Cloud* backup type.
- *History*: Displays the history for previous SFTP backups.

Restore

Restore allows you to restore to LiveWire a backup that was previously performed on LiveWire. To perform a restore, you will need the backup file you want to restore from and any password associated with the backup.

- *Application settings*: Select this option to restore the appliance application settings and customizations.
- *Application and system settings*: Select this option to restore the appliance, application settings, and customizations.
- *Backup File*: Click **Browse** to select the backup file from which you are restoring.
- *Encryption Password*: Enter the password for the backup from which you are restoring.
- *Restore*: Click to start the restore.

SFTP

SFTP allows you to configure an SFTP (Secure FTP) server for backing up the application and system settings on LiveWire.

The screenshot shows the LiveAdmin interface. On the left is a dark sidebar with the 'LiveAdmin' logo and a menu of options: DASHBOARD, AUTHENTICATION, MONITOR, NETWORK, OMNI (highlighted), SUPPORT, REMOTE SYSLOG, TIME, TLS, and UPDATE. The main content area is titled 'Omni' and contains a sub-menu with 'Centralized Management', 'Factory Reset', 'Backup', 'Restore', 'SFTP' (highlighted), and 'SNMP'. The 'SFTP Settings' form includes the following fields: 'SFTP Server*' (containing '127.0.0.1'), 'Port*' (containing '22'), 'Username*' (containing 'Username'), 'Password*' (containing 'Password' with a toggle icon), and 'Directory*' (containing '/data/backup'). At the bottom of the form are 'Save' and 'Test' buttons.

- **SFTP Server:** Type the IP address of the SFTP server.
- **Port:** Type the port used for the SFTP Server.
- **Username:** Type a username.
- **Password:** Type a password for the SFTP server.
- **Directory:** Type the directory where backups are saved on the SFTP server.

SNMP

SNMP settings allow you to configure the SNMP Credentials *Authentication Key* and *Privacy Key* for LiveWire.

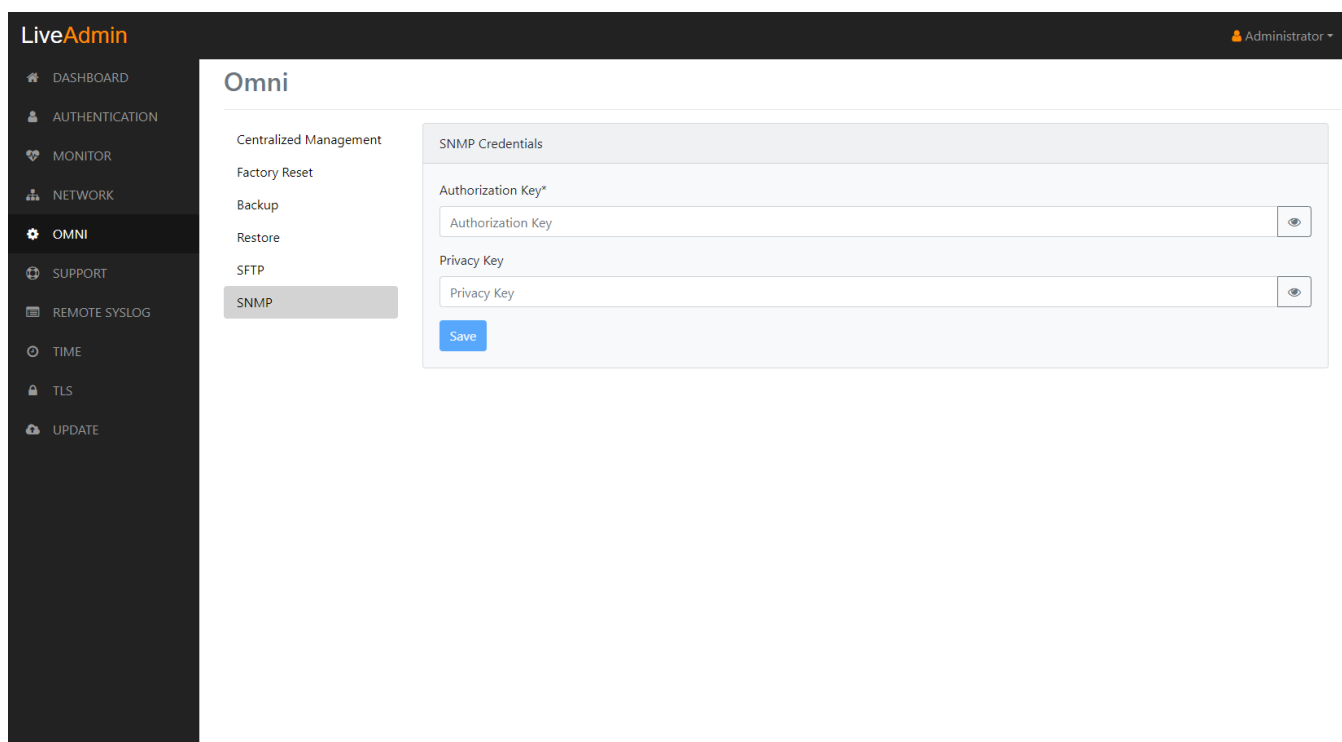

- **Authorization Key:** Type a new *Authorization Key* to change it from the default *Authorization Key* displayed in 'LiveNX SNMP Configuration' in 'LiveFlow' on page 107.
- **Privacy Key:** Type a new *Privacy Key* to change it from the default *Privacy Key* displayed in 'LiveNX SNMP Configuration' in 'LiveFlow' on page 107.
- **Save:** Click to apply the SNMP credentials to the device.

Support

The *Support* view lets you generate a diagnostic and support data report from LiveWire that would be helpful in troubleshooting issues.

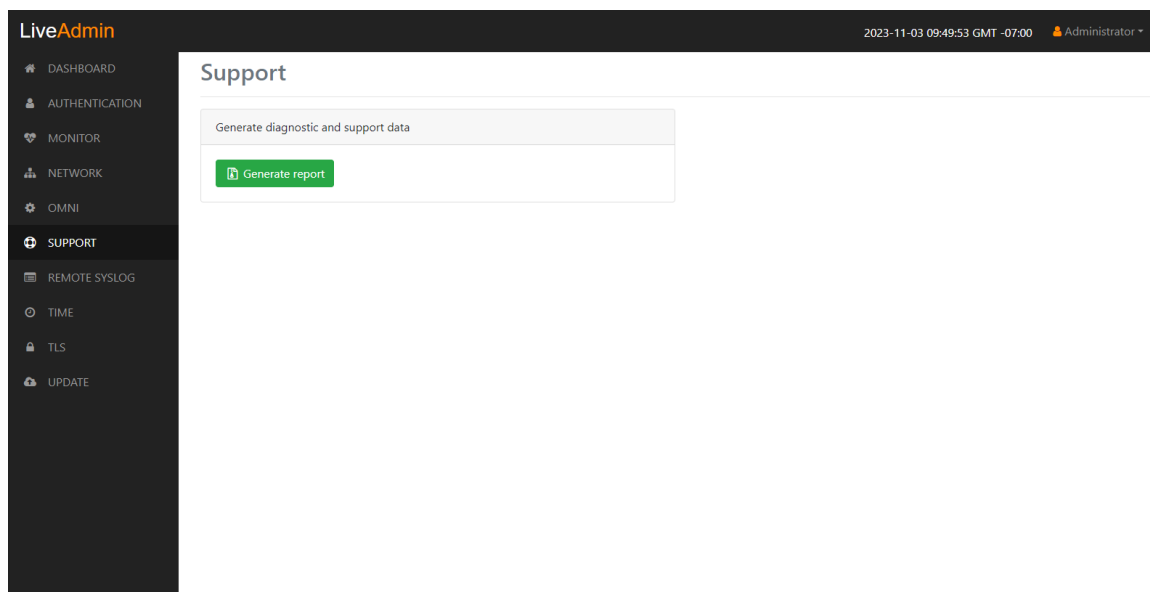

- **Generate Report:** Click to generate a diagnostic and support data report.

Remote Syslog

The *Remote Syslog* view lets you configure a remote syslog server that receives all system logs.

- **Server:** Enter the IP address of the remote syslog server.
- **Port:** Enter the Port address of the remote syslog server.
- **Protocol:** Select either TCP or UDP for the protocol.
- **Save:** Click to save the *Remote Syslog* settings.

Time

The *Time Configuration* view lets you configure the system's Timezone and NTP servers.

- **Timezone:** The Timezone setting lets you specify the physical location of LiveWire. Select from the list the location closest to your LiveWire.

- **NTP Servers:** The NTP (Network Time Protocol) server setting displays the NTP servers used to synchronize the clocks of computers over a network. Many features of LiveWire require accurate timestamps to properly analyze data.

To synchronize the LiveWire clock, you can specify the IP address of an NTP server located on either the local network or Internet. Once an NTP server is added to LiveWire, you can update (edit) or delete a server displayed in the list.

- **Add Server:** Click to add a new NTP server to the list. Enter the IP address of the **Server**, and optional **Key Type (MD5, SHA1)** and **Key**, and click **Save** (green check) to save the server to the list. Multiple NTP servers can be defined.
- **Submit:** Click to save your changes to LiveWire.

TLS

The **TLS Certificates** view lets you change the self-signed certificates that Omnipex and LiveAdmin use for HTTPS.

- **Public Certificate* (PEM):** Click **Choose File** to browse and select your Public Certificate file. Click the information icon to display an example of the file.
- **Private Key* (RSA unencrypted):** Click **Choose File** to browse and select your Private Key file. Click the information icon to display an example of the file.
- **CA Certificate (PEM optional):** Click **Choose File** to browse and select your CA Certificate file. Click the information icon to display an example of the file.
- **Upload:** Click to upload the selected files to LiveWire.

Update

The Update view lets you update the appliance using the software update package.

Note Updating the software will cause the system to reboot.

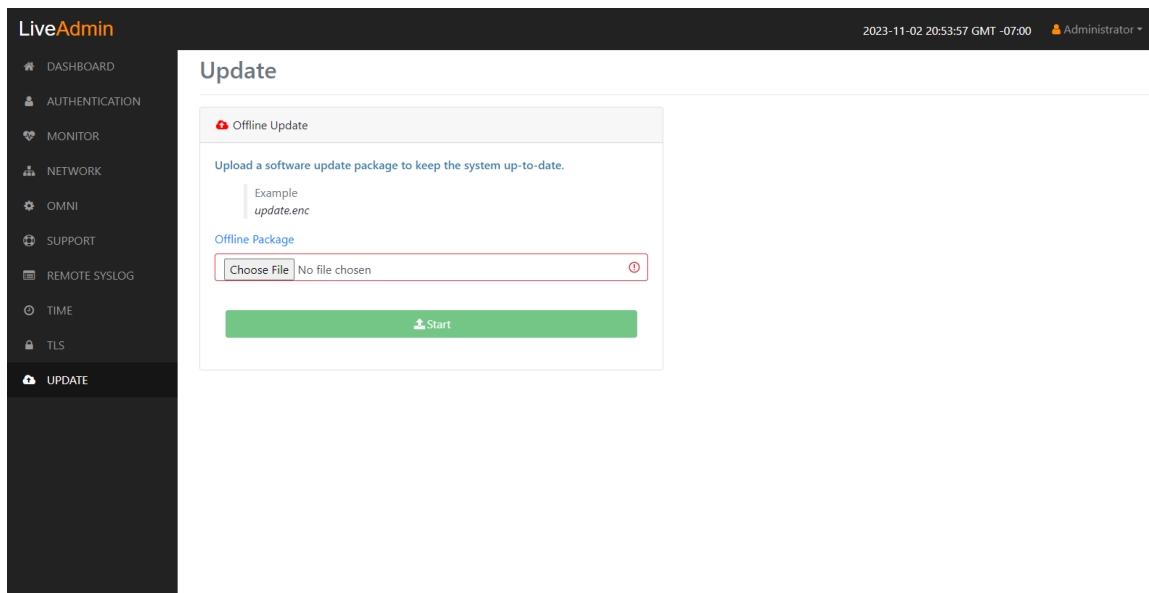

To update the software:

1. Download the latest software update package to your system.
2. Click **Choose File** and select the software update package.
3. Click **Start** to upload the package and begin the update process.

Once the update process is complete, the system restarts. A restart message is broadcast to all users connected to the appliance.

Restart and power off

The *Administrator* context menu at the top of the LiveAdmin utility has options that let you restart and power off LiveWire and log out from the utility.

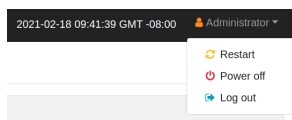

To restart LiveWire:

1. Click the *Administrator* context menu and select **Restart**.
2. Click **Yes, restart now!** to confirm the restart.

To power off LiveWire:

1. Click the *Administrator* context menu and select **Power off**.
2. Click **Power Off** to confirm you want to power off.

To log out of the LiveAdmin utility:

- Click the *Administrator* context menu and select **Log out**.

Using Grid to manage and configure LiveAction appliances

If you have one or more LiveAction appliances, you can use LiveAction Grid to manage and configure these appliances from the cloud. In order to use the Grid server for the LiveAction appliance, you must first enable the *Enable Centralized Management Settings* option in the LiveAdmin utility as described in 'Omni' on page 39.

Note When *Centralized Management Settings* are enabled, you can make local changes to the LiveAction appliance using the LiveAdmin utility; however, changes made with Grid will overwrite any local changes made with the utility.

Note All Grid communications require that the LiveAction appliance has Internet access and is able to access various websites including <https://mypeek.liveaction.com> and <https://cloudkeys.liveaction.com> using TCP over port 443. If necessary, configure a DNS server to resolve the URLs above.

Additionally, all Grid communications are initiated by the LiveAction appliance, so it is not necessary to open a port in the firewall for communications.

To use Grid to manage and configure LiveAction appliances:

1. Log into LiveAction Grid using the link provided by LiveAction when the appliance was purchased.

Note A link to LiveAction Grid and a temporary password is emailed to the customer whenever a LiveAction appliance is purchased. Use the customer email and temporary password to log into Grid. You will be required to change the temporary password upon first login.

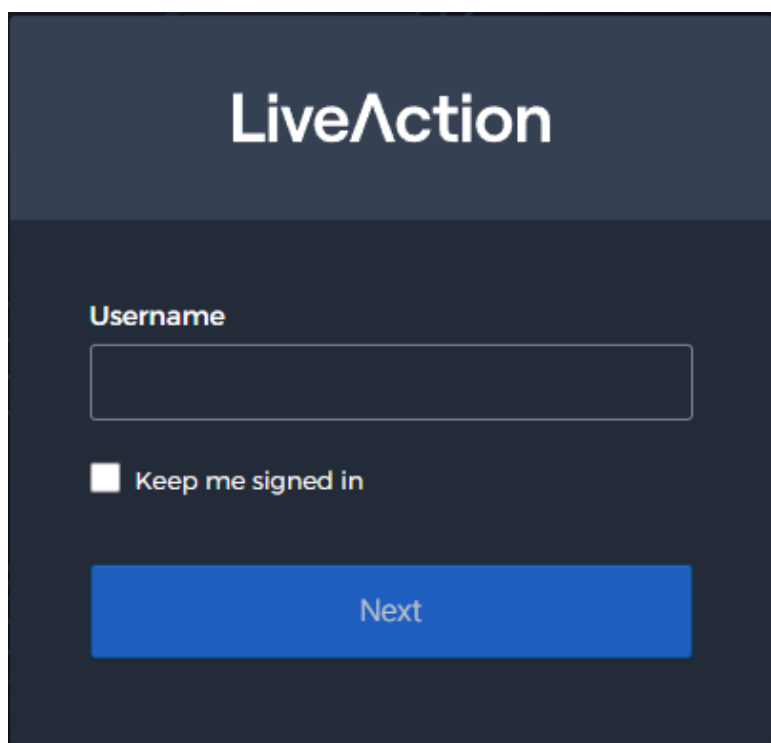

2. Enter the Username, and click **Next**.

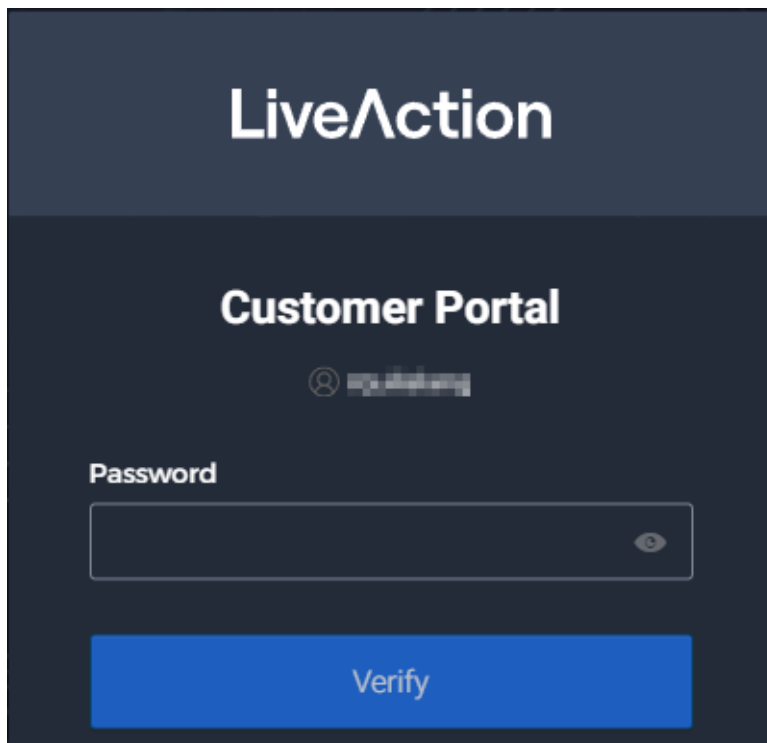

3. Enter your Password, and click **Verify**.

Grid Devices tab

The Grid *Devices* tab displays the LiveWire devices associated with the user's account. A description of each of the available options and settings in the *Devices* tab is provided below:

DEVICES	TEMPLATES	SEARCH	EXPORT					
Device State: Up 7 Down 2 N/A 19	Registered Devices: 9 of 28	Activation Status: 9 of 28	Decommissioned Devices: 1					
DEVICE SERIAL	DEVICE NAME	HOST NAME	DEVICE STATE	IP ADDRESS	MODEL	LOCATION	ADDRESS	ASSET TAG
<input checked="" type="checkbox"/>	D4C8243	3100	PNC	Up	10.8.102.12	PowerCore		
<input type="checkbox"/>	SV201809501919	Capture Engine fro...	liveaction-1919	Up	10.10.10.89	PowerCore		
<input type="checkbox"/>	LA202111600180	Capture Engine	chris-livewire-updat...	Up	10.0.0.106	Edge		
<input type="checkbox"/>	responseTest1			N/A		Edge		
<input type="checkbox"/>	6d74893f-f824-47fa...			N/A		Virtual		
<input type="checkbox"/>	responseTest2			N/A		Edge		
<input type="checkbox"/>	testadd450			N/A		Edge		
<input type="checkbox"/>	12345			N/A		PowerCore_cg		
<input type="checkbox"/>	BummerTest			N/A		Edge		
<input type="checkbox"/>	responseTest3			N/A		Edge		
<input type="checkbox"/>	9991336547			N/A		Virtual		

Device State

The *Device State* displays whether the device is able to connect to Grid.

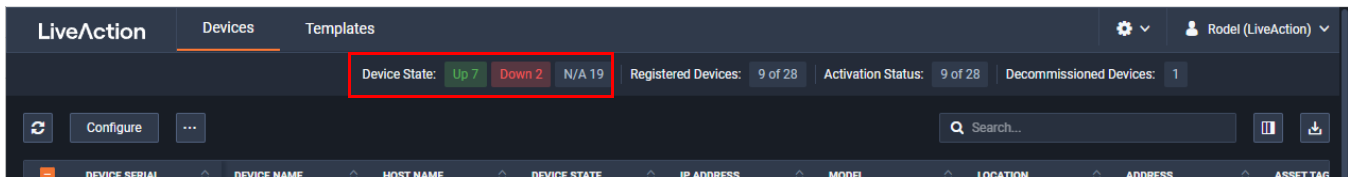

- *Up*: Displays the number of devices that were able to connect to Grid.
- *Down*: Displays the number of devices Grid has not heard from in the last two intervals. The default interval is 10 minutes.
- *N/A*: Displays the number of devices that are not available to Grid.

Registered Devices

The *Registered Devices* displays the number of devices that have registered with Grid.

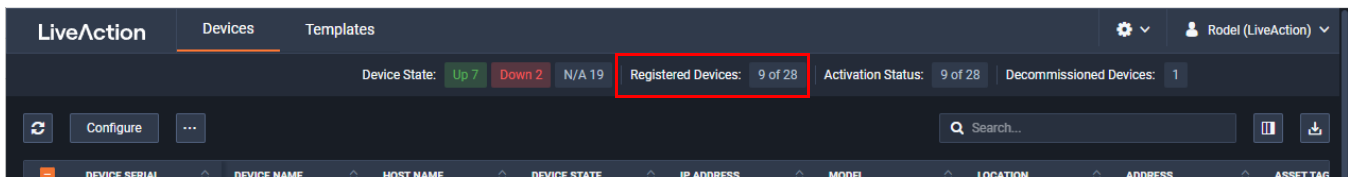

Activation Status

The *Activation Status* displays the number of devices that have been activated.

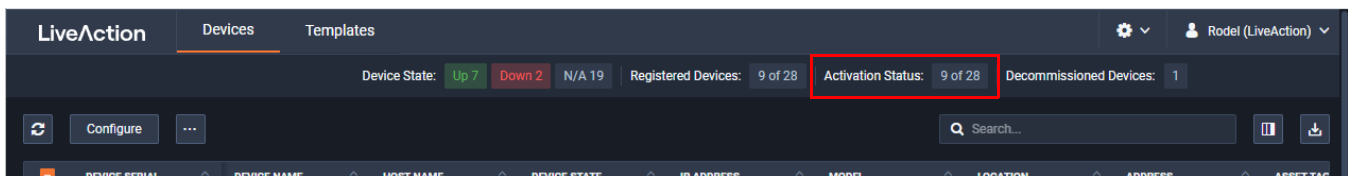

Decommissioned Devices

The *Decommissioned Devices* displays the number of devices that have been deactivated.

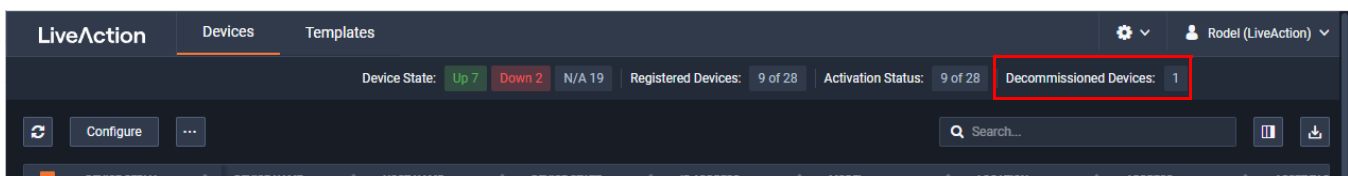

Refresh

Click **Refresh** to refresh the list of devices.

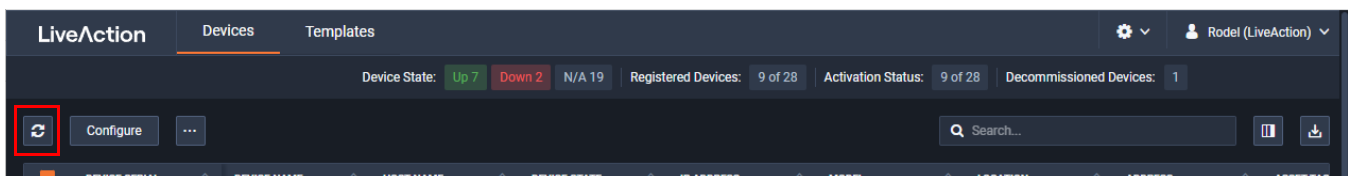

Configure

Click to display the *Configure* settings to configure the selected device. See 'Configuring a Device' on page 54 for descriptions of each of the settings.

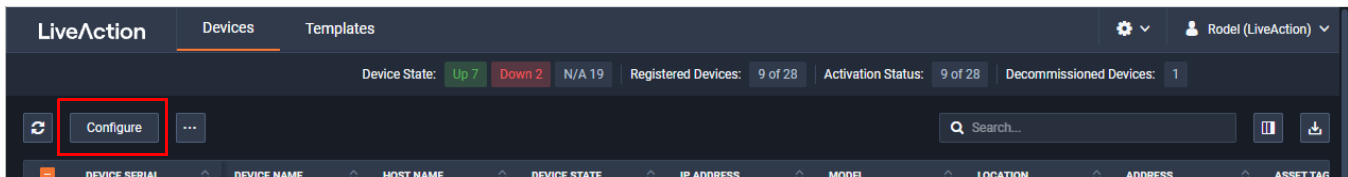

Elipsis (...)

Click the **Elipsis (...)** to view the following settings for the selected devices:

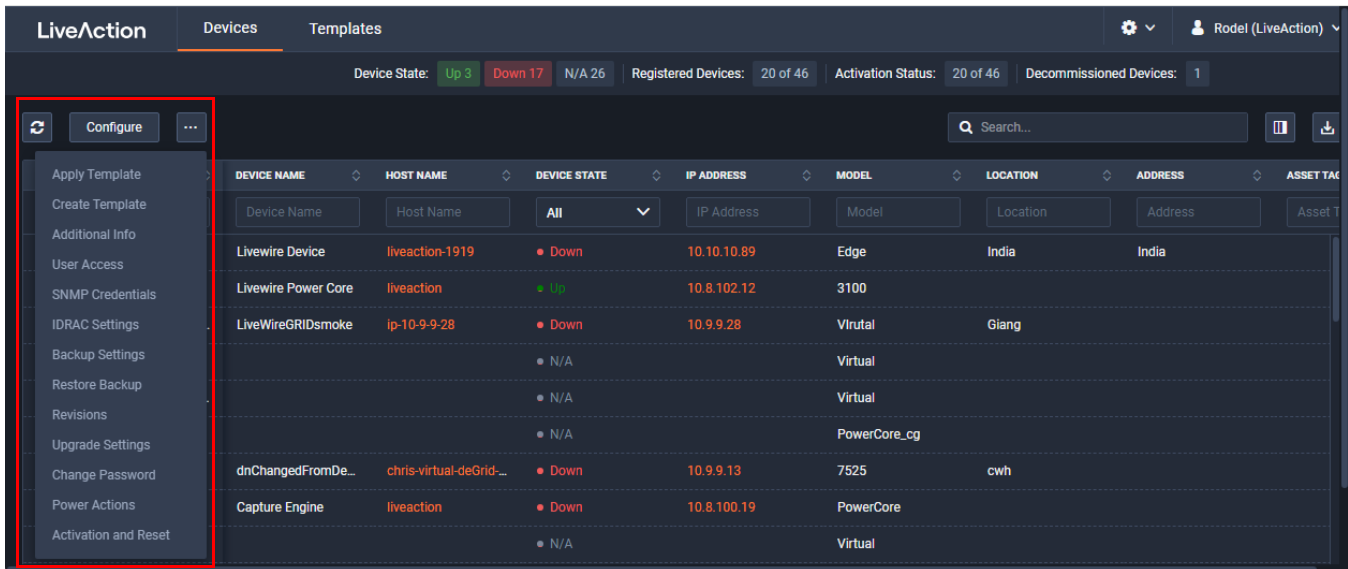

- *Apply Template.* See 'Grid Templates tab' on page 71
- *Create Template.* See 'Grid Templates tab' on page 71
- *Additional Info.* See 'Additional Info' on page 60.
- *User Access.* See 'Additional Info' on page 60.
- *SNMP Credentials.* See 'SNMP Credentials' on page 61.
- *IDRAC Settings.* See 'IDRAC Settings' on page 62.
- *Backup Settings.* See 'Backup Settings' on page 64.
- *Restore Backup.* See 'Restore Backup' on page 66.
- *Revisions.* See 'Revisions' on page 67.
- *Upgrade Settings.* See 'Upgrade Settings' on page 67.
- *Change Password.* See 'Change Password' on page 68.
- *Power Actions.* See 'Power Actions' on page 69.
- *Activation and Reset.* See 'Activation and Reset' on page 70.

Search

Use the *Search* field to locate a specific device in the list of devices. Simply enter a text string to display all appliances that match the text string.

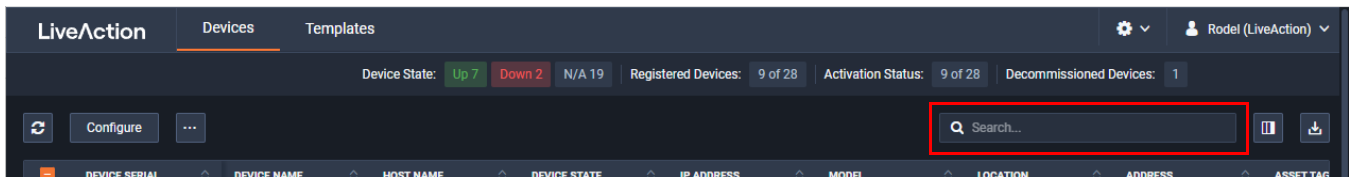

Display Columns

Click the **Display Columns** icon and then select the columns you want to display in the list of devices.

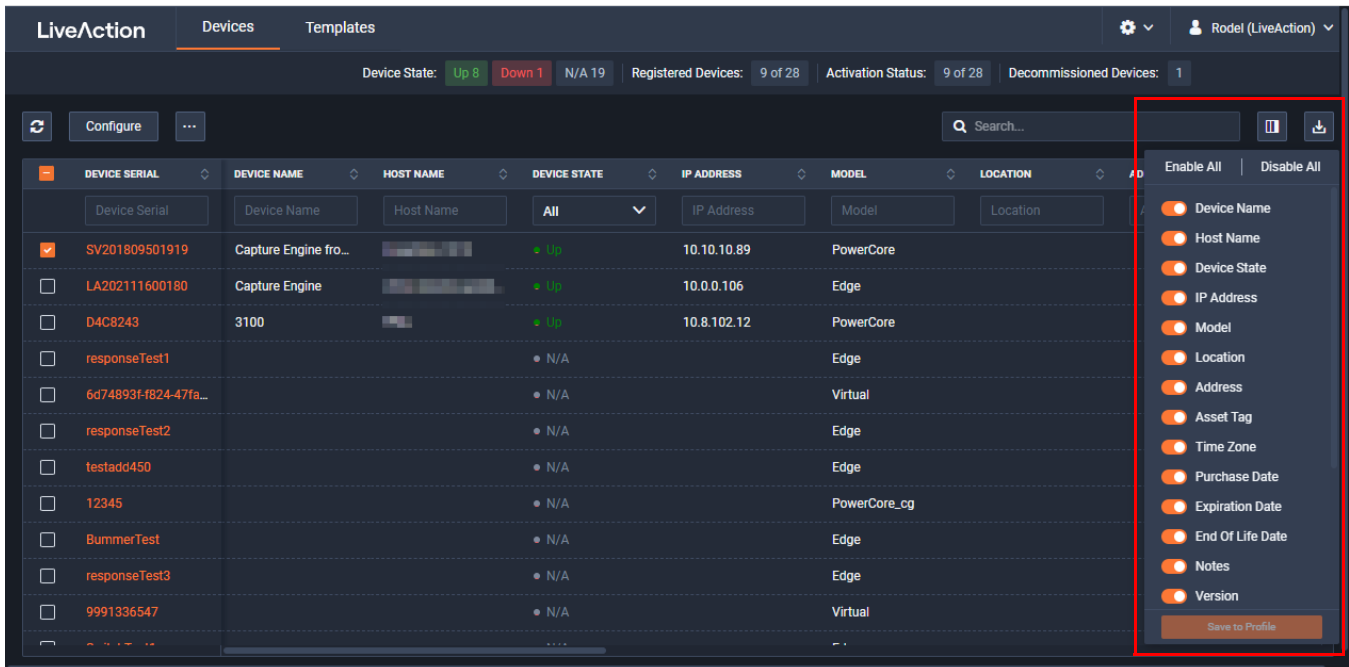

Export to CSV

Click the **Export to CSV** icon (...) to export the list of devices to a .csv file.

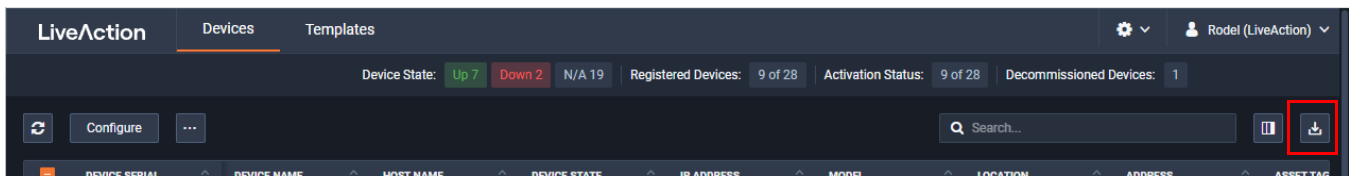

Check Box

To select a device in the list of devices, select the check box of the desired devices. Selecting the check box at the top of the column allows you to select or clear the check boxes of all devices in the list of devices.

DEVICE SERIAL	DEVICE NAME	HOST NAME	DEVICE STATE	IP ADDRESS	MODEL	LOCATION	ADDRESS	ASSET TAG
D4CB243	3100	PNC	Up	10.8.102.12	PowerCore			
SV201809501919	Capture Engine fro...	liveaction-1919	Up	10.10.10.89	PowerCore			
LA202111600180	Capture Engine	chris-livewire-updat...	Up	10.0.0.106	Edge			
responseTest1			N/A		Edge			
6d74893f-f824-47fa...			N/A		Virtual			
responseTest2			N/A		Edge			
testadd450			N/A		Edge			
12345			N/A		PowerCore_cg			
BummerTest			N/A		Edge			
responseTest3			N/A		Edge			
9991236547			N/A		Virtual			

Devices column headings

Descriptions of the columns displayed in the list of devices are provided below.

Tip Below each of the column headings is either a text box or list box that you can use to filter the devices displayed in the list of Devices. To filter using the text box, simply enter a text string to display the devices that match the text string. To filter using a list box, click the box and select an option to display the devices that match that option.

DEVICE SERIAL	DEVICE NAME	HOST NAME	DEVICE STATE	IP ADDRESS	MODEL	LOCATION	ADDRESS	ASSET TAG
Device Serial	Device Name	Host Name	All	IP Address	Model	Location	Address	Asset T
D4CB243	3100	PNC	Up	10.8.102.12	PowerCore			
SV201809501919	Capture Engine fro...	liveaction-1919	Up	10.10.10.89	PowerCore			
LA202111600180	Capture Engine	chris-livewire-updat...	Up	10.0.0.106	Edge			
responseTest1			N/A		Edge			
6d74893f-f824-47fa...			N/A		Virtual			
responseTest2			N/A		Edge			
testadd450			N/A		Edge			
12345			N/A		PowerCore_cg			
BummerTest			N/A		Edge			
responseTest3			N/A		Edge			
9991236547			N/A		Virtual			

- *Device Serial*: Displays the serial number of the device.
- *Device Name*: Displays the name of the device.
- *Host Name*: Displays the host name of the device used by DNS.
- *Device State*: Displays whether the device is *Up* or *Down*. A device is up if it has contacted Grid in the last 20 minutes.

- **IP Address:** Displays the IP address of the device. The *IP Address* value is a link which can be used to connect directly to Omnippeek running on the device. This makes it easy to use the Grid as a launch pad to access all of the devices being managed. It can also be used to discover the *IP Address* in the case where the device is set to DHCP, or for some other reason the *IP Address* is not known. The *IP Address* is provided by the device every time the device connects back to the portal, which by default is every 10 minutes. This way, if the *IP Address* of the device changes, the *IP Address* value displayed in Grid will reflect that.
- **Model:** Displays the model of the device (e.g., *Edge*, *Core*, *PowerCore*, or *Virtual*).
- **Location:** Displays the location of the device.
- **Address:** Displays the address of the device. Typically, this is the mailing address where the device is located.
- **Asset Tag:** Displays the asset tag of the device.
- **Time Zone:** Displays the time zone of the device.
- **Purchase Date:** Displays the purchase date of the device.
- **Expiration Date:** Displays the date that the maintenance on the device will expire. Once the expiration date has passed, you can still access Grid and use it to manage most of the device configuration; however, until the maintenance is renewed, the device cannot be upgraded to a newer version. As LiveAction releases new versions a few times a year with significant improvements, we recommend keeping the devices up to date with the latest releases of the software.
- **End Of Life Date:** Displays the date for when the device should be replaced.
- **Notes:** Displays any notes entered for the device.
- **Version:** Displays the version number of the software installed on the device.
- **Engine Type:** Displays the type of device, which can be *LiveWire*, *LiveCapture*, or *LiveWire Virtual*.
- **User Count:** Displays the number of secondary users that have access to the device.
- **Scheduled Action(s):** Displays any 'Actions' scheduled for the device.
- **Configuration Status:** Displays any status associated with configuration of the device.
- **Registered:** Displays a check mark if the device has been registered with LiveAction.
- **Activation Status:** Displays a check mark if the license on the device is valid and not expired.

Configuring a Device

Click the *Configure* button to configure the selected devices. If multiple devices are selected, certain configuration options will not be available and greyed out; for example, the *Device Name*. The options to configure a device are available in the left-hand pane of the window. Each of the options are described below.

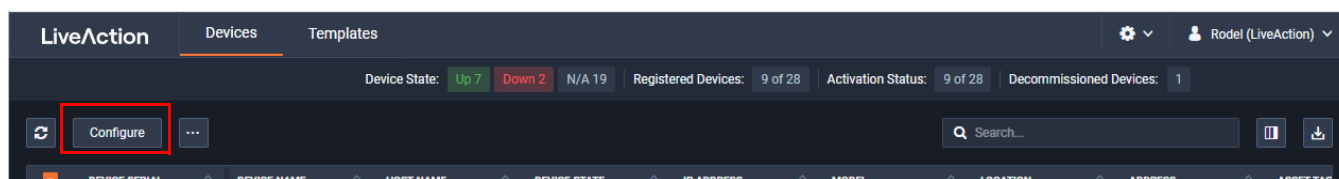

Apply Template

Apply Template lets you apply the settings from templates that have been saved to Grid.

The screenshot shows the 'Apply Template' dialog box in the LiveAction interface. The dialog box is titled 'Apply Template (12345)' and contains a table with columns 'TEMPLATE NAME' and 'VERSION'. The table lists several templates, with 'LR202004011658-24.1.0.3-1' selected. Below the table are 'Cancel' and 'Apply' buttons. To the right of the dialog box is the 'Template Details' panel, which shows configuration options for the selected template, including Template Name, Version, Time Zone, NTP Servers, and Backup Settings.

TEMPLATE NAME	VERSION
D4C8243-23.4.2.1	23.4
<input checked="" type="radio"/> LR202004011658-24.1.0.3-1	24.1
LA202011502510-23.3.1.1-21	23.3
LR202004011658-24.1.0.3	24.1
ryne	23.4
SV201809501919-23.4.0.14	23.4
LR202004011658-23.4.0.14	23.4
LA202111600180-23.2.0.11-14	23.2

Template Details

Configure

Template Name: LR202004011658-24.1.0.3-1

Template Version: 24.1

Time Zone: America/New_York

NTP Servers:

- 0.ubuntu.pool.ntp.org
- 1.ubuntu.pool.ntp.org
- 2.ubuntu.pool.ntp.org
- 3.ubuntu.pool.ntp.org
- ntp.ubuntu.com

Third Party Auth: Disabled

User Access

Owner: ghoang@liveaction.com

Shared: -

Backup Settings

SFTP Connection: -

Schedule: Disabled

Filename Prefix: _GiangOnEdge197

Date and Time: 2023-07-11T17:08:00.000Z

Backup Interval: 1 days

Retention Limit: 5 backups

Encryption: Not Configured

IDRAC Settings

HostName: -

Domain Name: -

- *Template Name*: Displays the template name. Select the template to apply to the selected device.
- *Version*: Displays the version number of the template. You can select the template versions to display.
- *Apply*: Click to apply the template to the selected device.

Create Template

Select *Create Template* to create a template based on the settings of the selected device. The template is created immediately and is made available in the *Templates* tab.

Configure

Select *Configure* to view and modify settings of the selected devices.

The screenshot shows the 'Configure' page for a device with ID 12345. The interface is divided into several sections:

- Device Name *:** A text input field labeled 'Device Name'.
- Host Name *:** A text input field labeled 'Host Name'.
- IPv4 settings:**
 - IP Assignment:** A dropdown menu currently set to 'Static'.
 - Address *:** A text input field for the IP address.
 - Netmask *:** A text input field for the netmask.
 - Gateway *:** A text input field for the gateway address.
- DNS Server:** A text input field labeled 'Enter DNS server'.
- IPv6 settings:**
 - IP Assignment:** A dropdown menu currently set to 'Disabled'.
- Time Settings:**
 - Time Zone *:** A dropdown menu currently set to 'Africa/Abidjan'.
- NTP Server:** A text input field labeled 'Enter NTP server'.

At the bottom of the configuration form are three buttons: 'Cancel', 'Revert', and 'Apply'. The right sidebar contains 'Device Details' and 'Configure' sections with various status and configuration parameters.

Settings

- **Device Name:** Displays the unique name given to the device. Type a new name to change the name.
- **Host Name:** Displays the host name of the device used by DNS. Type a new name to change the name.

IPv4 settings

- **IP Assignment:** Displays the current IP assignment for the device. You can select either *DHCP* or *Static*. If the IP Assignment is *DHCP*, then the IP assignment is configured automatically via the DHCP server. If the IP Assignment is *Static*, then the options below are available:

Important! LiveWire is pre-configured to obtain an IP address automatically from a DHCP server; however, we strongly recommend the use of a static IP address for LiveWire. If DHCP is selected as the *IP Assignment*, and if the address should change on a new DHCP lease, then the user must look up the new IP address assigned to LiveWire.

Note If *DHCP* is selected, you have approximately two minutes to connect LiveWire to your network in order for the DHCP server to assign an IP address. If an IP address is not assigned to LiveWire by the DHCP server within two minutes of being connected to the network, LiveWire defaults to a static address of 192.168.1.21. Please make sure LiveWire is connected to your network within the two minute time period from the time you click **Apply**. If you reboot LiveWire, the two minute clock is also reset.

- **Address:** Displays the IP address assigned to the device. Type a new address to change the IP address.

- **Netmask:** Displays the netmask address assigned to the device. A netmask address, combined with the IP address, defines the network associated with device. Type a new address to change the netmask address.
- **Gateway:** Displays the gateway address, also known as 'default gateway,' assigned to the device. When the device does not have an IP route for the destination, the IP packet is sent to this address as it does not know how to direct it locally. Only a single default gateway can be defined. Type a new address to change the gateway address.
- **DNS:** Enter the address of any DNS (Domain Name Server) servers to add to the configuration. A Domain Name Server translates domain names (e.g., www.liveaction.com) into an IP address. To add a DNS server, enter the address of the server. Multiple DNS name servers can be defined. You can also delete any defined DNS servers.

IPv6 settings

- **IP Assignment:** Displays the current IP assignment for the device. You can select either *DHCP* or *Static*. If the IP Assignment is *DHCP*, then the IP assignment is configured automatically via the DHCP server. If the IP Assignment is *Static*, then the options below are available:

Important! LiveWire is pre-configured to obtain an IP address automatically from a DHCP server; however, we strongly recommend the use of a static IP address for LiveWire. If DHCP is selected as the *IP Assignment*, and if the address should change on a new DHCP lease, then the user must look up the new IP address assigned to LiveWire.

Note If *DHCP* is selected, you have approximately two minutes to connect LiveWire to your network in order for the DHCP server to assign an IP address. If an IP address is not assigned to LiveWire by the DHCP server within two minutes of being connected to the network, LiveWire defaults to a static address of 192.168.1.21. Please make sure LiveWire is connected to your network within the two minute time period from the time you click **Apply**. If you reboot LiveWire, the two minute clock is also reset.

- **Address:** Displays the IP address assigned to the device. Type a new address to change the IP address.
- **Netmask:** Displays the netmask address assigned to the device. A netmask address, combined with the IP address, defines the network associated with device. Type a new address to change the netmask address.
- **Gateway:** Displays the gateway address, also known as 'default gateway,' assigned to the device. When the device does not have an IP route for the destination, the IP packet is sent to this address as it does not know how to direct it locally. Only a single default gateway can be defined. Type a new address to change the gateway address.
- **DNS:** Enter the address of any DNS (Domain Name Server) servers to add to the configuration. A Domain Name Server translates domain names (e.g., www.liveaction.com) into an IP address. To add a DNS server, enter the address of the server. Multiple DNS name servers can be defined. You can also delete any defined DNS servers.
- **Add Server:** Click to add the DNS server to the configuration.
- **DNS Servers:** Displays the DNS servers added to the configuration.
- **Edit DNS:** Click to edit or update the DNS server in the configuration.
- **Delete DNS:** Click to delete the DNS server from the configuration.
- **DHCP Timeout:** Displays the amount of time (in seconds) the device will wait for a DHCP address.

Time Settings

The screenshot shows the configuration page for a device in the LiveAction interface. The main content area is titled 'Configure (12345)'. It includes sections for IPv4 and IPv6 settings, Time Settings, and Authentication. The 'Time Settings' section is highlighted with a red box and contains a 'Time Zone' dropdown menu set to 'Africa/Abidjan' and an 'NTP Server' text input field. The 'Authentication' section has 'Enable OS authentication only' selected. The right sidebar shows 'Device Details' for device 12345, including fields for Device State, Registered, Activation Status, Configuration Status, Scheduled actions, Version, and various configuration parameters like Device Serial, Device Name, Host Name, IP Assignment, IP Address, Netmask, Gateway, DHCP Timeout, DNS Servers, IPv6 IP Assignment, IPv6 IP Address, IPv6 IP Prefix, IPv6 Gateway, IPv6 DNS Servers, Time Zone, NTP Servers, and Third Party Auth.

- **Time Zone:** Displays the time zone of the device. Select a different time zone to change the time zone.
- **NTP Server:** Enter the address of any NTP servers to add to the configuration, and then click **Add Server**.
- **NTP Servers:** Displays the list of NTP servers added to *Time Settings*. To add an NTP server, enter the address of the server. Multiple NTP servers can be defined. You can also delete any defined NTP servers.

Authentication

The screenshot shows the 'Configure' page for device 12345. The 'Authentication' section has two radio buttons: 'Enable OS authentication only' (unselected) and 'Enable third-party authentication' (selected). Below these are 'Add' and 'Delete' buttons, and a search bar. A table with columns 'NAME', 'TYPE', and 'IN USE' is present but empty, displaying 'No Data'. At the bottom are 'Cancel', 'Revert', and 'Apply' buttons. The right sidebar shows 'Device Details' and 'Configure' information for device 12345, including fields like Device Serial, Device Name, Host Name, IP Assignment, IP Address, Netmask, Gateway, DHCP Timeout, DNS Servers, IPv6 IP Assignment, IPv6 IP Address, IPv6 IP Prefix, IPv6 Gateway, IPv6 DNS Servers, Time Zone, NTP Servers, and Third Party Auth (Disabled).

- *Enable OS authentication only*: Select this option to use the local OS authentication.
- *Enable third-party authentication*: Select this option to use Active Directory, TACACS+, or RADIUS authentication. If this option is selected, click **Add** to configure the new authentication setting. The available settings will change depending on which type of authentication is selected by the user:

Note These options will change depending on which type of authentication is selected by the user.

- *Add*: Click to add a new authentication setting. You will need to configure the new authentication setting.
- *Delete*: Click to delete the selected authentication setting.
- *Search*: Enter the text string to search the list of authentication settings.
- *Name*: Enter the name of the authentication setting.
- *Type*: Select the type of authentication, which can be 'TACACS+', 'RADIUS' or 'Active Directory.'
- *Host*: Enter the host of the authentication setting.
- *Port*: Enter the port of the authentication setting.
- *Secret*: Enter the secret key of the authentication setting.
- *Use Now*: Enable or disable whether or not the authentication setting is in use.

Additional Info

Select *Additional Info* to edit various settings of the selected devices.

The screenshot shows the 'Additional Info' configuration modal for device 12345. The modal is highlighted with a red border and contains the following fields:

- Location:** Input field with the value 'Location'.
- Address:** Input field with the value 'Address'.
- Contact Person Name:** Input field with the value 'Contact Person Name'.
- Contact Person Number:** Input field with the value 'Contact Person Number'.
- Asset Tag:** Input field with the value 'Asset Tag'.
- Notes:** Text area containing the text 'test'.

At the bottom of the modal are three buttons: 'Cancel', 'Revert', and 'Apply'.

The background interface shows the 'LiveAction' header with 'Devices' and 'Templates' tabs. The left sidebar contains various configuration options, with 'Additional Info' selected. The right sidebar shows 'Device Details' for device 12345, including fields like Device State, Registered, Activation Status, Configuration Status, Scheduled actions, Version, and a 'Configure' section with various network and system settings.

- **Location:** Displays the general location of the device. Type a new location to change the location. We suggest entering the physical location of the device for the organization. For example, 'Office.'
- **Address:** Displays the mailing address of the device. For example, 123 Main St., New York, NY. Type a new address to change the address.
- **Contact Person Name:** Displays the contact person of the device. Type a new name to change the contact person.
- **Contact Person Number:** Displays the phone number of the contact person. Type a new number to change the phone number.
- **Asset Tag:** Displays the asset tag of the device. Type a new asset tag to change the asset tag.
- **Notes:** Displays any notes for the device. Type any new notes to update the notes.
- **Revert:** Click to clear the *Edit Additional Info* values.
- **Apply:** Click to apply the additional info to the device.

User Access

Select *User Access* to add or remove authorized users for your organization that have access to the selected devices.

The screenshot shows the LiveAction interface. At the top, there are tabs for 'Devices' and 'Templates'. The main content area is titled 'User Access (12345)'. It features a search bar and a table with columns for 'EMAIL ADDRESS', 'ROLE', 'FIRST NAME', and 'LAST NAME'. Below the table, it says 'No Data'. To the right, there is a 'Device Details' panel with various fields like 'Device State', 'Registered', 'Activation Status', etc.

- **Add:** Click to add an authorized user to have access to the device.
- **Delete:** Click to delete the selected user from list of users.
- **Search:** Use the *Search* field to locate a specific user in the list of users. Simply enter a text string to display all users that match the text string..
- **Email Address:** Displays the email address of the user.
- **Role:** Displays the role assigned to the user. A user can have the following roles.
 - **Admin:** Users in this role are able to view and modify/configure all devices and users that belong to the organization. Additionally they can add new users to the organization and are allowed to configure Single Sign On (SSO).
 - **Config:** Users in this role are able to view and configure any devices that have been shared to them by another user that has access. They cannot perform operations on user accounts or SSO.
 - **View:** Users in this role can only view devices that have been assigned to them and are not able to effect any changes within the system.
- **First Name:** Displays the first name of the user.
- **Last Name:** Displays the last name of the user.

SNMP Credentials

Select *SNMP Credentials* to configure the *SNMP Authentication Password* and *Privacy Password* for the selected devices.

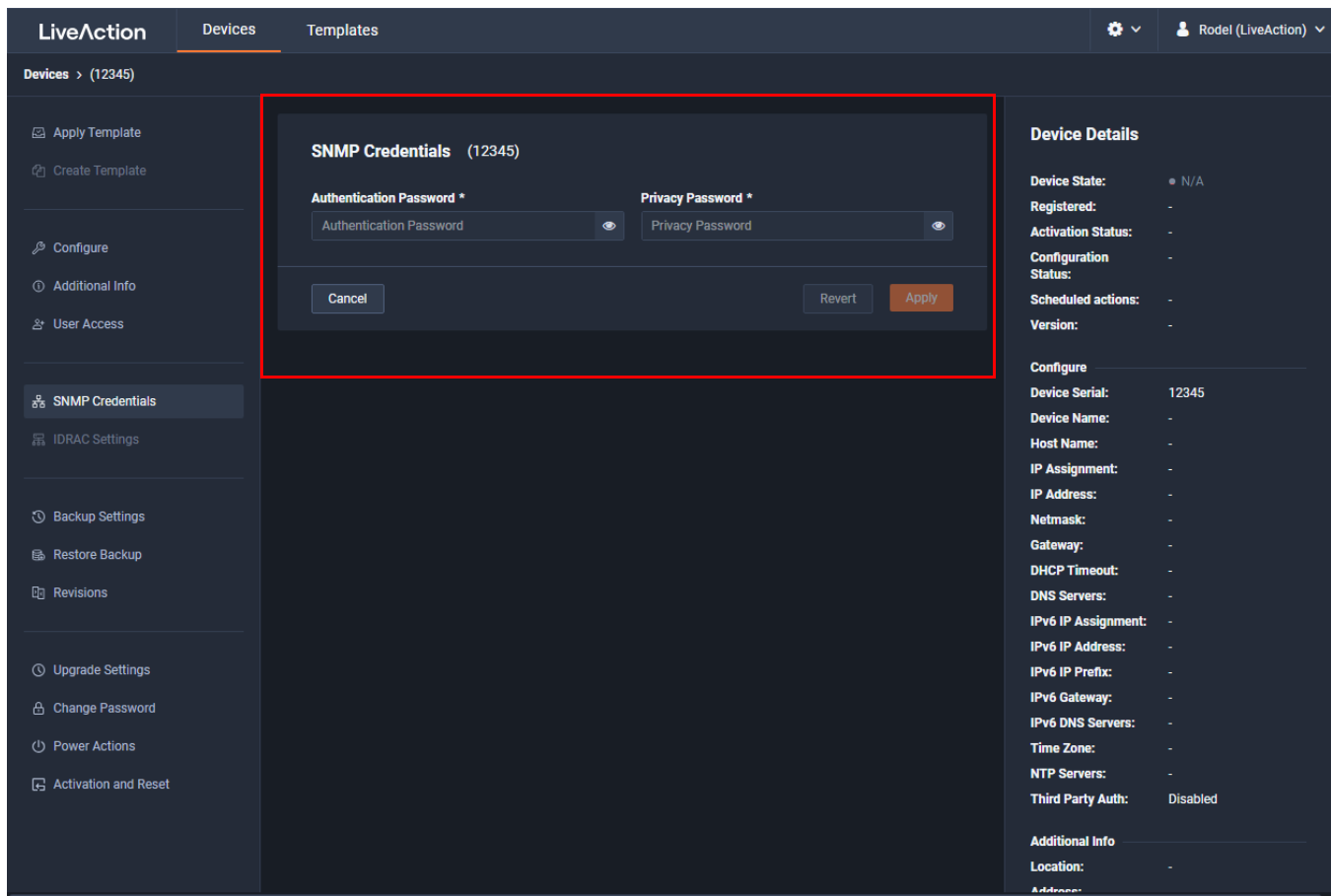

- **Authentication Password:** Type a new *Authentication Password* to change it from the default Authentication Password displayed in 'LiveNX SNMP Configuration' in 'LiveFlow' on page 107.
- **Privacy Password:** Type a new *Privacy Password* to change it from the default Authentication Password displayed in 'LiveNX SNMP Configuration' in 'LiveFlow' on page 107.
- **Revert:** Click to clear the *Edit Additional Info* values.
- **Apply:** Click to apply the SNMP credentials to the device.

IDRAC Settings

Select the *iDRAC Settings* to configure various options for LiveWire that would normally be configured by using the iDRAC utility on LiveWire. See also 'Integrated Remote Access Controller (iDRAC)' on page 85.

Note Only selected options available from the iDRAC utility are available and configurable below.

IDRAC Settings Livewire Power Core (D4C8243)

Hostname * **Domain Name** **Time Zone ***

DNS Server 1 **DNS Server 2**

Web Server TLS Version * Host Header Check

Network Settings

NIC IP Address * **NIC Gateway *** **NIC Subnet Mask ***

Authentication

Username * **Password ***

Update Settings

Enable Updates

Update Proxy Server * **Update Proxy User *** **Update Proxy Password ***

SNMP

Enable SNMP Enable SNMP Alert 1 Enable SNMP Alert 2

Device Details

Device State: + 100
Registered: +
Activation Status: +
Configuration Status: -
Scheduled actions: -
Version: 23.4.2.1

Configure

Device Serial: D4C8243
Device Name: Livewire Power Core
Host Name: liveaction
IP Assignment: Static
IP Address: 10.8.102.12
Netmask: 10.8.102.12
Gateway: 10.8.102.12
DHCP Timeout: 45
DNS Servers: [10.4.155.19](#)
IPv6 IP Assignment: Disabled
IPv6 IP Address: -
IPv6 IP Prefix: -
IPv6 Gateway: -
IPv6 DNS Servers: -
Time Zone: America/Los_Angeles
NTP Servers: [0.ubuntu.pool.ntp.org](#), [1.ubuntu.pool.ntp.org](#), [2.ubuntu.pool.ntp.org](#), [3.ubuntu.pool.ntp.org](#), [ntp.ubuntu.com](#)
Third Party Auth: Disabled

- **Hostname:** Displays the *Hostname* of the device. Type a new *Hostname* to change it.
- **Domain Name:** Displays the *Domain Name* of the device. Type a new *Domain Name* to change it.
- **Time Zone:** Displays the *Time Zone* of the device. Select a new *Time Zone* to change it.
- **DNS Server 1:** Displays the *DNS Server* used by the device. Enter a new *DNS Server* to change it.
- **DNS Server 2:** Displays the *DNS Server* used by the device. Enter a new *DNS Server* to change it.
- **Web Server TLS Version:** Displays the TLS protocol version support used by the device. You can select from the following: TLS 1.1 and Higher, TLS 1.2 Only, TLS 1.2 and Higher, and TLS 1.3
 - **Host Header Check:** Select to enable *Host Header Check* requests.

Network Settings

- **NIC IP Address:** Displays the static *NIC IP Address* of the device. Type a new *NIC IP Address* to change it.
- **NIC Gateway:** Displays the *NIC Gateway* of the device. Type a new *NIC Gateway* to change it.
- **NIC Subnet Mask:** Displays the *NIC Subnet Mask* of the device. Type a new *NIC Subnet Mask* to change it.

Authentication

- **Username:** Displays the *Username* of the device. Type a new *Username* to change it.
- **Password:** Configures the *Password* of the device. Type a new *Password* to change it.

Update Settings

- **Enable Updates:** Select to enable updates on the device. If enabled, you must configure the Update Proxy Server, Update Proxy User, and Update Proxy Password.
- **Update Proxy Server:** Displays the *Update Proxy Server* of the device. Type a new *Update Proxy Server* to change it.
- **Update Proxy User:** Displays the *Update Proxy User* of the device. Type a new *Update Proxy User* to change it.
- **Update Proxy Password:** Displays the *Update Proxy Password* of the device. Type a new *Update Proxy Password* to change it.

SNMP

- **Enable SNMP:** Select to enable the SNMP Agent on the iDRAC. If enabled, you must configure the *SNMP Community*.
 - **SNMP Community:** Configures the *SNMP Community* name used for SNMP Agents. Type a new *SNMP Community* name to change it
- **Enable SNMP Alert 1:** Select to enable the *SNMP Alert 1* on the iDRAC. If enabled, you must configure the *Alert 1 Target Address*.
 - **Alert 1 Target Address:** Displays the IPv4, IPv6, FQDN address, or hostname of the target destination to receive alerts. Must be valid IPv4, IPv6, FQDN address, or hostname.
- **Enable SNMP Alert 2:** Select to enable the *SNMP Alert 2* on the iDRAC. If enabled, you must configure the *Alert 2 Target Address*.
 - **Alert 2 Target Address:** Displays the IPv4, IPv6, FQDN address, or hostname of the target destination to receive alerts. Must be valid IPv4, IPv6, FQDN address, or hostname.

NTP

- **Enable NTP:** Select to enable an *NTP* server on the iDRAC. If enabled, you must configure the *NTP Server*.
 - **NTP Server:** Displays the name or IP address of the *NTP Server*. Type a new name or IP address to change it.

Event Filters

- **Alert:** Displays any iDRAC Event filters configured for the device.
- **Add:** Click to add a new Event filter configured in the text box. You must provide any parameters by defining what you want to be alerted to and how you want to be notified. You can configure as many event filter commands as you want. The general format of an alert category:

idrac.alert.category.[subcategory].[severity]

- **Revert:** Click to clear the *iDRAC Settings* values.
- **Apply:** Click to apply the *iDRAC Settings* to the device.

Backup Settings

Select *Backup Settings* to set up and configure a backup for the selected device. See 'Backup and restore' on page 82 for instructions on performing an actual backup.

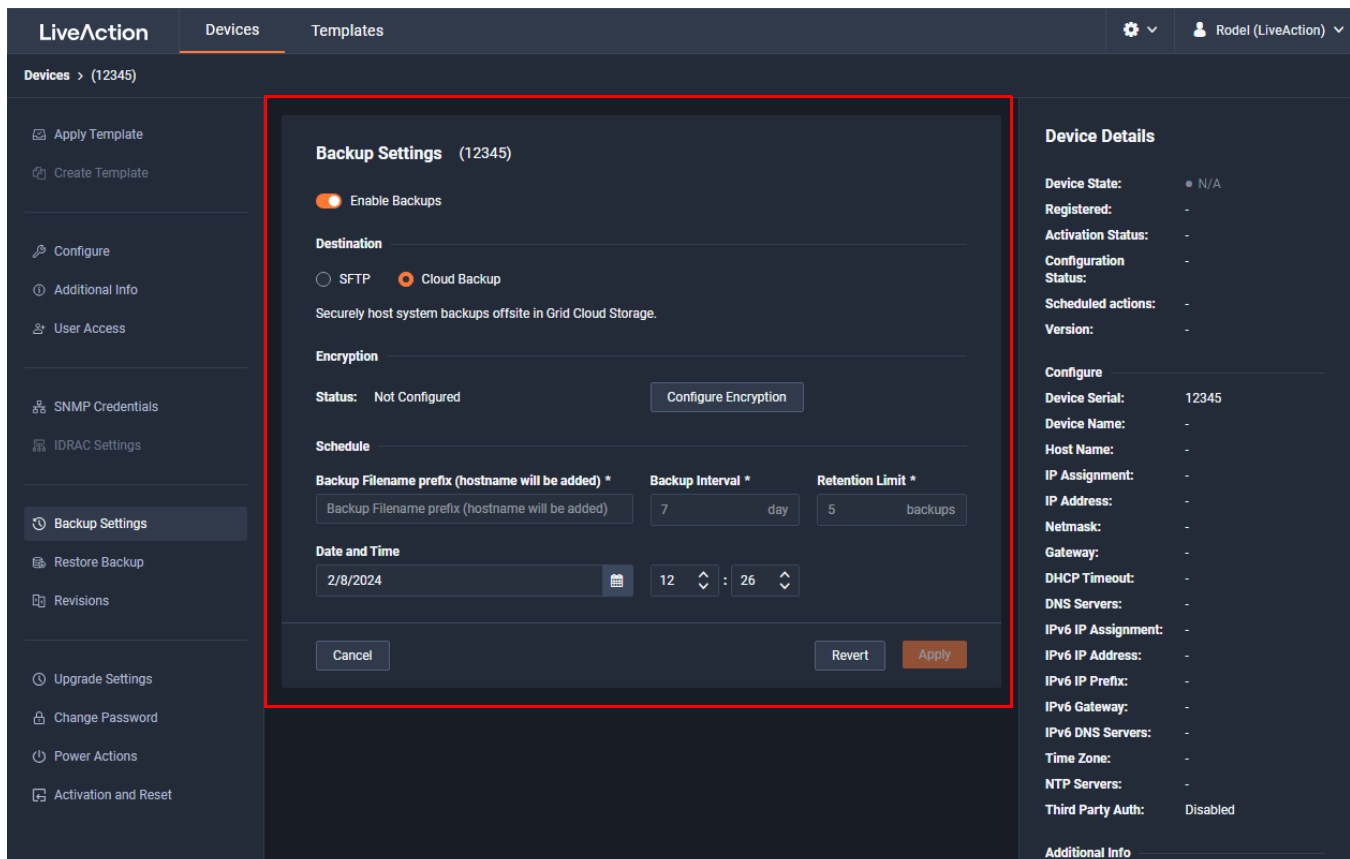

- **Enable Backups:** Select to enable or disable the backups configured below.

Destination

- **SFTP:** Select to configure the SFTP (Secure FTP) server for the backup, and then click *Configure SFTP*.
 - **Hostname:** Type the IP address of the SFTP server.
 - **Port:** Type the port used for the SFTP Server.
 - **Username:** Type a username.
 - **Password:** Type a password for the SFTP server.
 - **Directory:** Type the directory where backups are saved on the SFTP server.
- **Delete:** Click to delete the configured SFTP server for the backup.
- **Cloud Backup:** Select to securely host system backups offsite in Grid Cloud Storage.

Encryption

- **Status:** Displays whether or not encryption is configured for each scheduled backup.
- **Configure Encryption:** Click to configure security settings to encrypt each scheduled backup.
 - **Encrypt backups:** Select this option to encrypt each scheduled backup.
 - **Password:** Type the password for each scheduled backup.
 - **Repeat Password:** Type the password again to verify the password.

Schedule

- **Backup Filename prefix:** Type a prefix filename for the backup. Each scheduled backup that is created will append the prefix to the beginning of the backup filename.

- *Backup Interval*: Type the number of days between YADA.
- *Retention Limit*: Type the number backups to YADA.
- *GMT Date and Time*: Type or select the GMT date and time the backup will complete.

Restore Backup

Select *Restore Backup* to restore a backup from an earlier backup. See 'Backup and restore' on page 82 for instructions on performing an actual restore.

The screenshot shows the 'Restore Backup' dialog in the LiveAction interface. The dialog is titled 'Restore Backup Livewire Power Core (D4C8243)'. It contains a table with the following columns: ACTION, STATUS, FILE NAME, BACKUP TIME, and LOCATION. The table lists several backup records, some with a 'Restore' action and 'Success' status, and others with a 'Restore' action and 'Deleted' status. A 'Cancel' button is located at the bottom left of the dialog.

ACTION	STATUS	FILE NAME	BACKUP TIME	LOCATION
Restore	Success	config_3100PNC_liveaction...	2024-02-07T21:53:33.911Z	backups/001W000000Nyc4I...
Restore	Success	config_3100PNC_liveaction...	2024-02-06T21:54:36.814Z	backups/001W000000Nyc4I...
Restore	Success	config_3100PNC_liveaction...	2024-02-05T21:52:51.853Z	backups/001W000000Nyc4I...
Restore	Deleted	config_3100PNC_liveaction...	2024-02-04T21:56:37.733Z	backups/001W000000Nyc4I...
Restore	Deleted	config_3100PNC_liveaction...	2024-02-03T21:52:53.387Z	backups/001W000000Nyc4I...
Restore	Deleted	config_3100PNC_liveaction...	2024-02-02T22:05:44.479Z	backups/001W000000Nyc4I...

- *Action*: Click **Restore** to restore a backup for the device. You will need to select to restore either *Application Settings* or *Application and System Settings*.
 - *Application Settings*: Select this option to restore all application settings and customizations, including capture templates, filters, graphs, alarms, notifications, name table, SSL certificates, and custom plugins.
 - *Application and System Settings*: Select this option to restore all application settings and customizations, including capture templates, filters, graphs, alarms, notifications, name table, SSL certificates, and custom plugins. Additionally, all system settings are restored and include all new and/or updated users, SNMP, NTP, network, time zone, and host customizations.
 - *Password*: Type the password of the backup you are restoring.
 - *Restore*: Click to perform the restore.
- *Status*: Displays the status of the backup.
- *File Name*: Displays the name of the backup.
- *Backup Time*: Displays the date and time the backup was completed
- *Location*: Displays the location of the backup.

Revisions

Select *Revisions* to view the current settings of the device. You can also select a *Revision Version* to view settings previously applied to the device, and if necessary apply those previous settings to the device.

The screenshot shows the 'Revisions' page for the device 'Livewire Power Core (D4C8243)'. The page is divided into three main sections: 'Settings', 'Current Version', and 'Revision Version'. The 'Settings' section is currently selected and displays a list of configuration parameters. The 'Current Version' section shows the current settings for the device. The 'Revision Version' section is currently empty, indicating that no previous revisions have been applied.

Settings	Current Version	Revision Version
Configure		
Device Serial	D4C8243	
Device Name	Livewire Power Core	
Host Name	liveaction	
IP Assignment	STATIC	
IP Address	10.8.102.12	
Netmask	255.255.255.0	
Gateway	10.8.102.1	
DNS Servers	10.4.155.19	
DHCP Timeout	45	
IPv6 IP Assignment	Disabled	
IPv6 IP Address	-	
IPv6 IP Prefix	-	
IPv6 Gateway	-	
IPv6 DNS Servers		

- *Settings*: Displays the settings that can be applied to a device.
- *Current Version*: Displays the settings currently applied to a device.
- *Revision Version*: Displays the settings previously applied to a device. You must select the *Revision Version* to display.
- *Apply*: Click to apply the settings from the *Revision Version* currently displayed above to a device.

Upgrade Settings

Select *Upgrade Settings* to upgrade the selected appliance remotely through Grid. The version that the appliance is upgraded to is the latest shipping version of the appliance. There is no capability to upgrade to a previously released version.

The screenshot displays the LiveAction interface. At the top, there are tabs for 'Devices' and 'Templates'. The main area is titled 'Devices > (12345)'. A sidebar on the left contains various configuration options, with 'Upgrade Settings' highlighted. A modal dialog box titled 'Upgrade Settings (12345)' is open in the center. It features an 'Enable Upgrade' toggle switch that is currently turned on. Below this is a 'Date and Time' section with a date input field showing '2/15/2024' and a time input field showing '12 : 36'. At the bottom of the dialog are three buttons: 'Cancel', 'Revert', and 'Apply'. To the right of the dialog, a 'Device Details' panel is visible, showing various device attributes such as Device State, Registered, Activation Status, Configuration Status, Scheduled actions, Version, and a 'Configure' section with fields for Device Serial, Device Name, Host Name, IP Assignment, IP Address, Netmask, Gateway, DHCP Timeout, DNS Servers, IPv6 IP Assignment, IPv6 IP Address, IPv6 IP Prefix, IPv6 Gateway, IPv6 DNS Servers, Time Zone, NTP Servers, and Third Party Auth.

- **Enable Upgrade:** Select to enable or disable the upgrade on the selected devices.
- **GMT Date and Time:** Type or select the GMT date and time the upgrade should take place. Because all communications are initiated from the device once every ten minutes, the upgrade will happen as the result of the device communicating with the network, sometime on or after the selected time.
- **Revert:** Click to clear the *Upgrade Settings* values.
- **Apply:** Click to apply the *Upgrade Settings* to the device.

Change Password

Select *Change Password* to change the password of the selected devices.

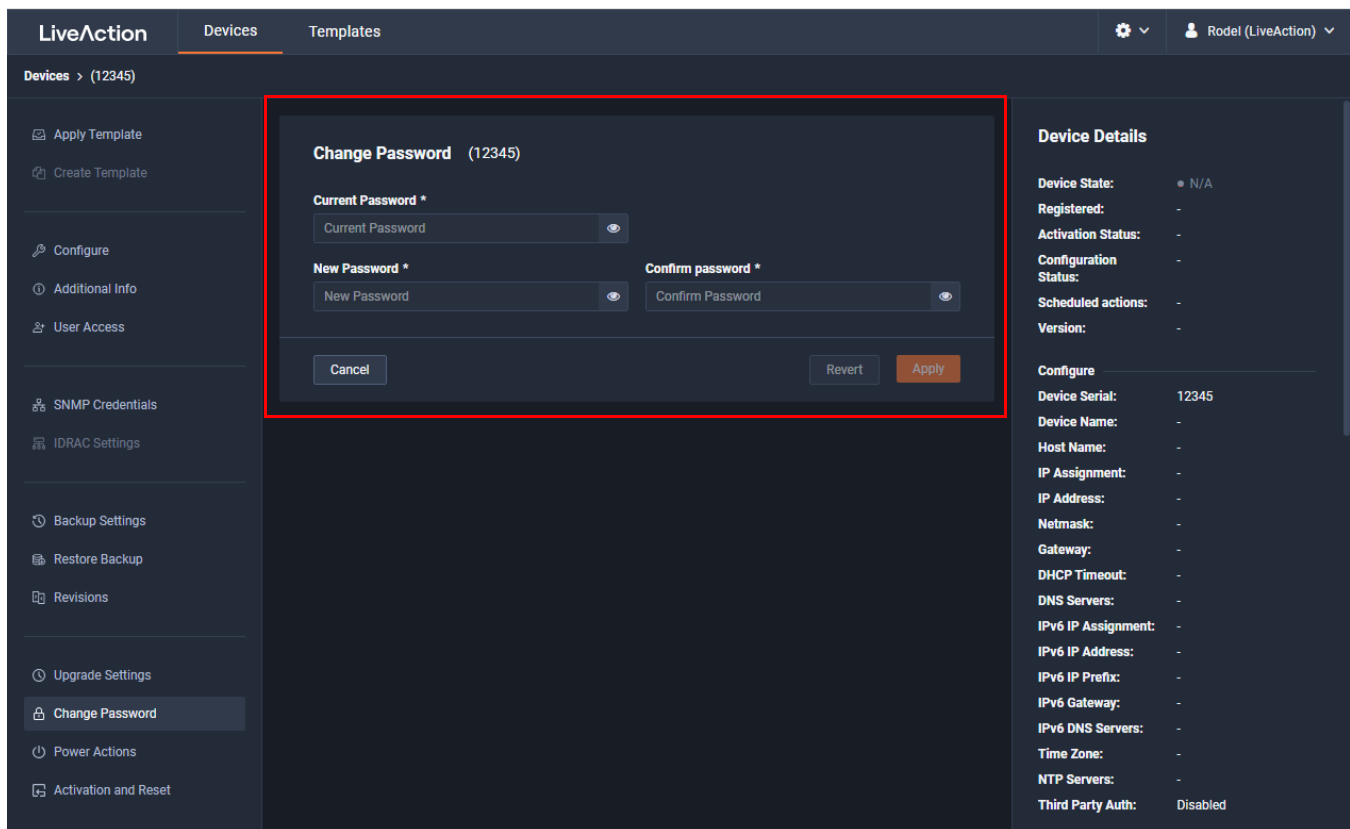

- *Current Password*: Enter the current password.
- *New Password*: Enter the new password. The new password must meet the following requirements:
 - Must have 5 different characters than the last password.
 - Must be at least 6 characters.
 - Must contain at least 1 number
 - Must contain at least 1 uppercase character.
 - Must contain at least 1 lowercase character.
 - Must contain at least 1 special character.
- *Confirm Password*: Enter the new password again.
- *Revert*: Click to clear the *Change Password* values.
- *Apply*: Click to apply the *Change Password* to the device.

Power Actions

Select *Power Actions* to perform the actions below on the selected devices.

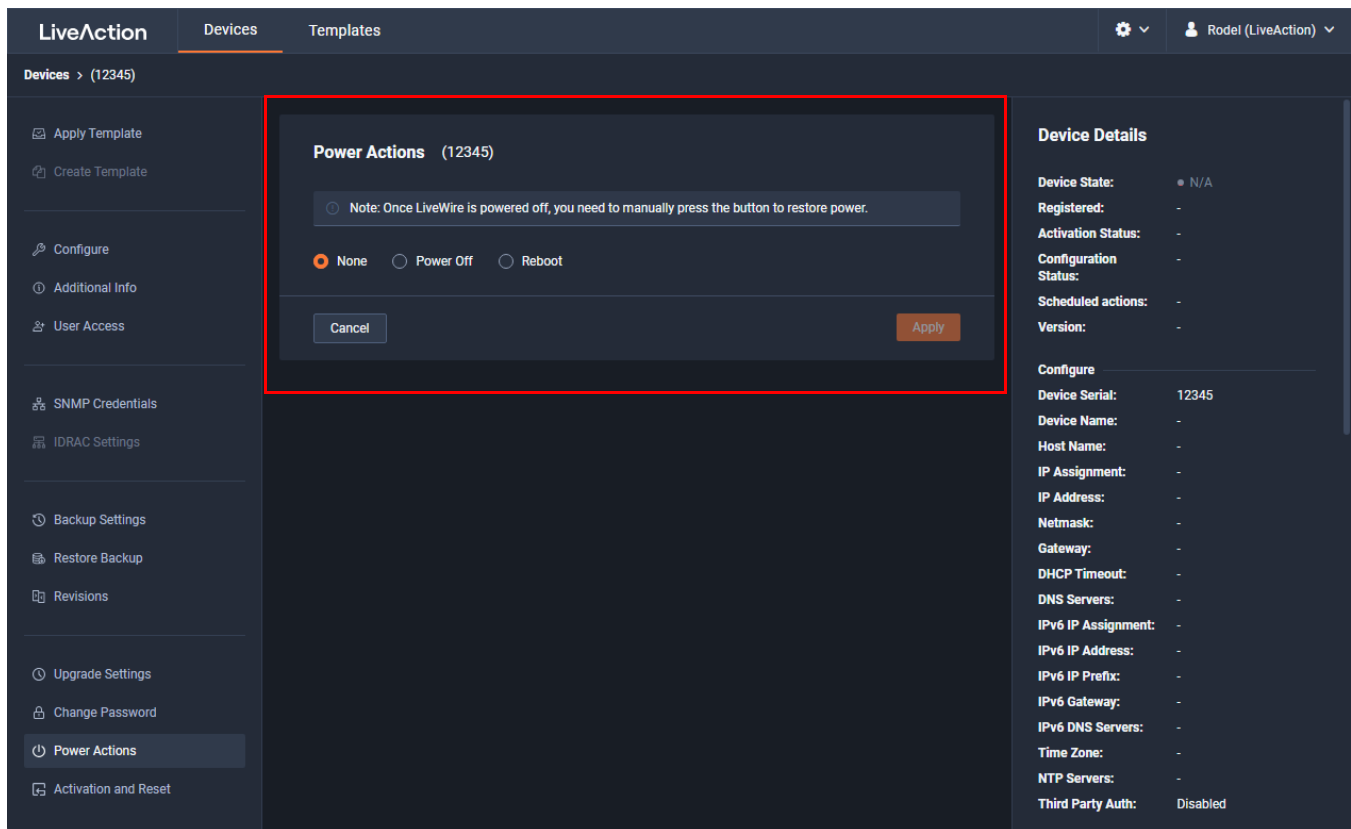

- **None:** Select to not perform an action on the selected device.
- **Power Off:** Select to power off the selected device. Once the device is powered off, you must manually press the power-on button on each of the devices to power them back on.
- **Reboot:** Select to reboot the selected appliances.
- **Factory Reset:** Select to reset the selected appliances to their factory default settings.

Activation and Reset

Select *Activation and Reset* to perform one of the three options below on the selected devices.

The screenshot shows the 'Activation and Reset' dialog box for device 12345. The dialog is titled 'Activation and Reset (12345)' and contains three radio buttons: 'None' (selected), 'Refresh License', and 'Factory Reset'. Below the radio buttons are 'Cancel' and 'Apply' buttons. The background shows the 'Devices' tab with a list of actions on the left and 'Device Details' on the right.

- *None*: Select to not perform an action on the selected device.
- *Refresh License*: Select to refresh the license on the selected device.
- *Factory Reset*: Select to reset the selected devices to their factory default settings.

Grid Templates tab

The Grid *Templates* tab displays the templates saved to your account. Templates allow you to configure settings independent of a particular device, and then apply the template, and thus the settings, to a device, or multiple devices in bulk at the same time. A description of each of the available options and settings in the *Templates* tab is provided below:

The screenshot shows the 'Templates' tab in the LiveAction interface. The 'Templates' tab is highlighted with a red box. Below the tab, there is a table with columns: TEMPLATE NAME, VERSION, TIMEZONE, SHARED, and OWNER. The table contains three rows of templates.

TEMPLATE NAME	VERSION	TIMEZONE	SHARED	OWNER
Template 1	23.2	America/Los_Angeles	x	rquilalang@liveaction.com
Template 2	23.2	America/New_York	x	rquilalang@liveaction.com
Template 3	23.2	Asia/Tokyo	x	rquilalang@liveaction.com

Refresh

Click *Refresh* to refresh the list of templates.

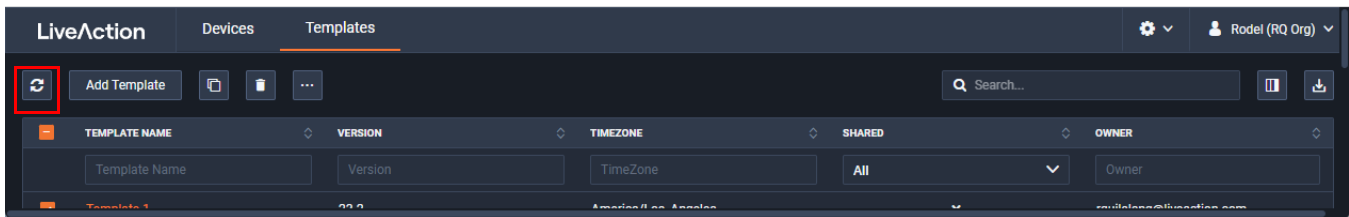

Add Template

Click *Add Template* to display the *Configure* settings to configure the new template. See 'Configure' on page 55 for descriptions of each of the settings.

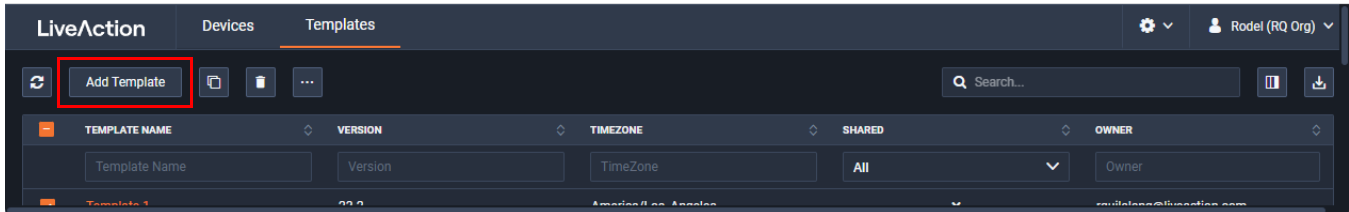

Duplicate Template

Click *Duplicate Template* to copy the selected template and add the copied template to the list of templates.

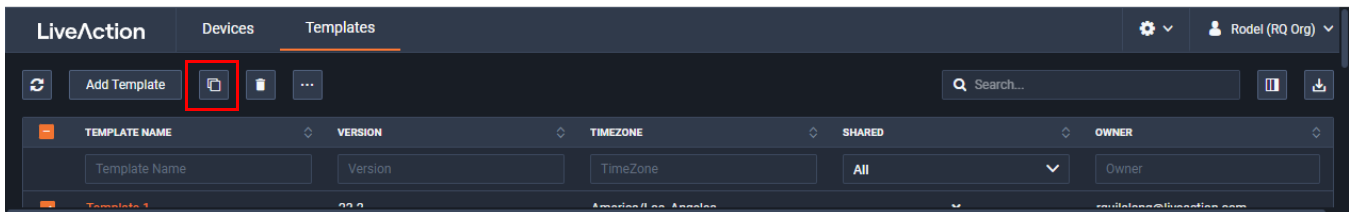

Delete Template

Click *Delete Template* to remove the selected template from the list of templates.

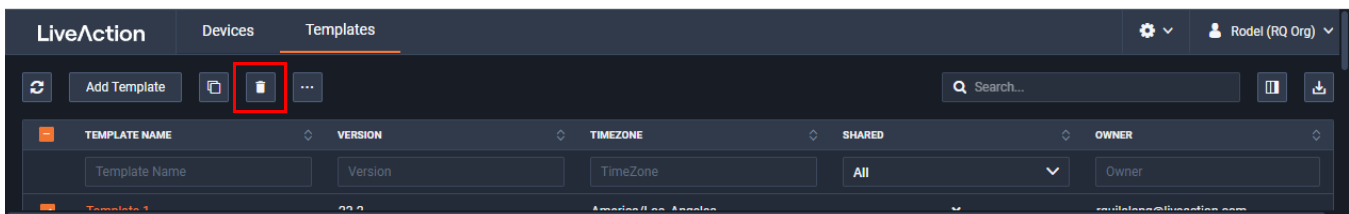

Elipsis (...)

Click the **Elipsis** (...) to view options for the selected template: The options available to configure templates are the same options used to configure a device. Follow the links below for descriptions of the settings.

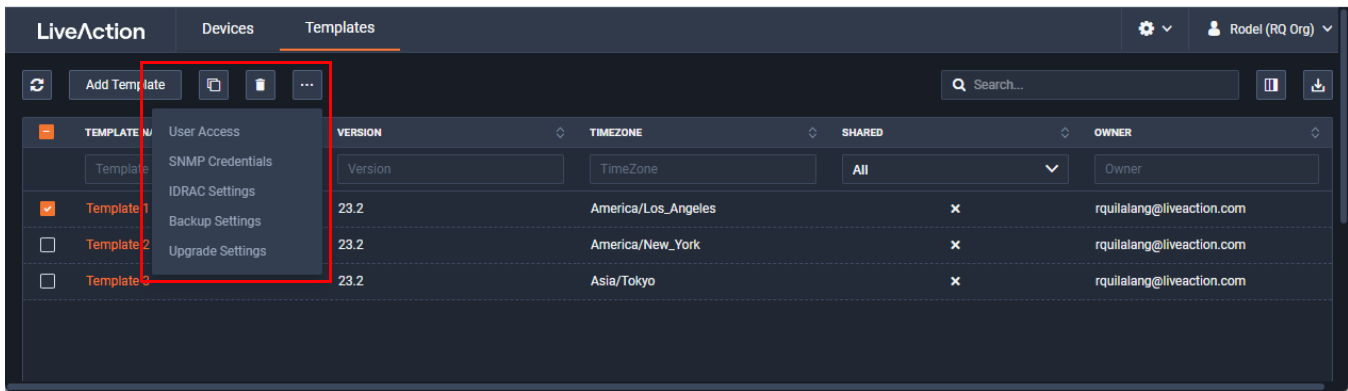

- *User Access*. See 'User Access' on page 60
- *SNMP Credentials*. See 'SNMP Credentials' on page 61
- *IDrac Settings*. See 'IDrac Settings' on page 62
- *Backup Settings*. See 'Backup Settings' on page 64
- *Upgrade Settings*. See 'Upgrade Settings' on page 67

Search

Use the *Search* field to locate a specific template in the list of templates. Simply enter a text string to display all templates that match the text string.

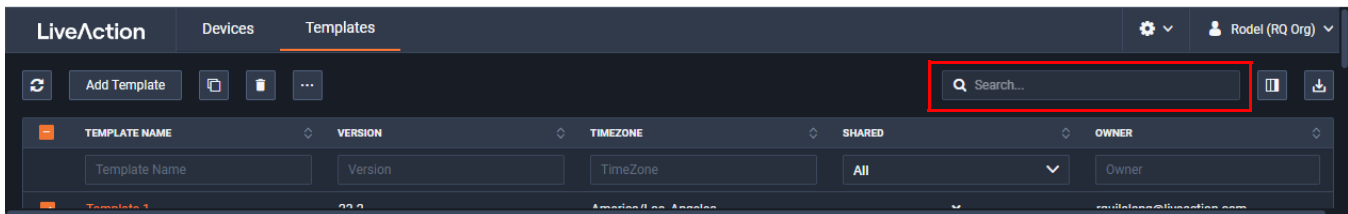

Display Columns

Click the *Display Columns* icon and then select the columns you want to display in the list of templates.

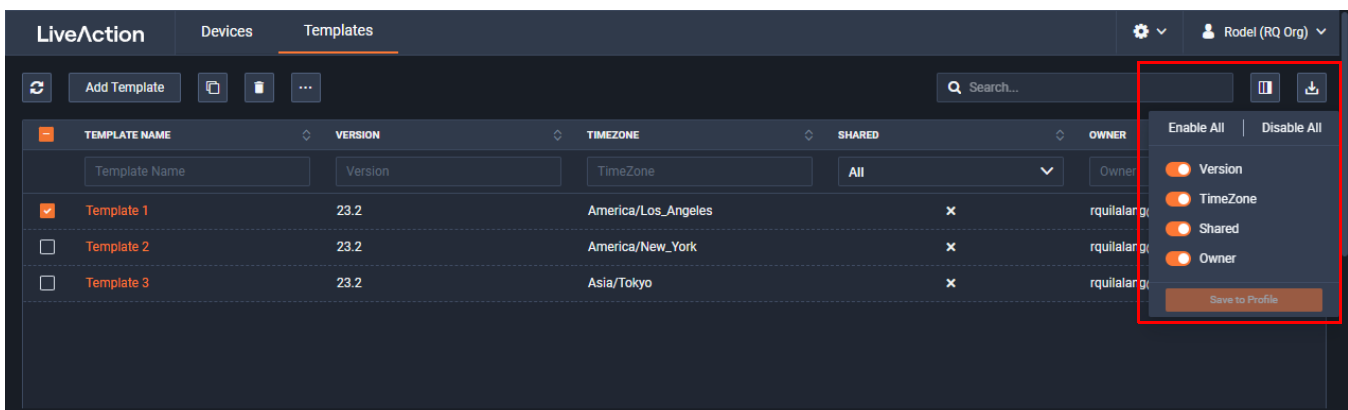

Export to CSV

Click the *Export to CSV* icon (...) to export the list of templates to a .csv file.

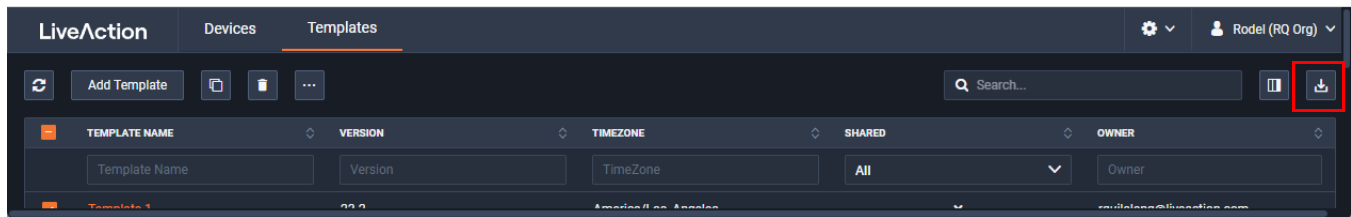

Check Box

To select a template in the list of templates, select the check box of the desired templates. Selecting the check box at the top of the column allows you to select or clear the check boxes of all templates in the list of templates.

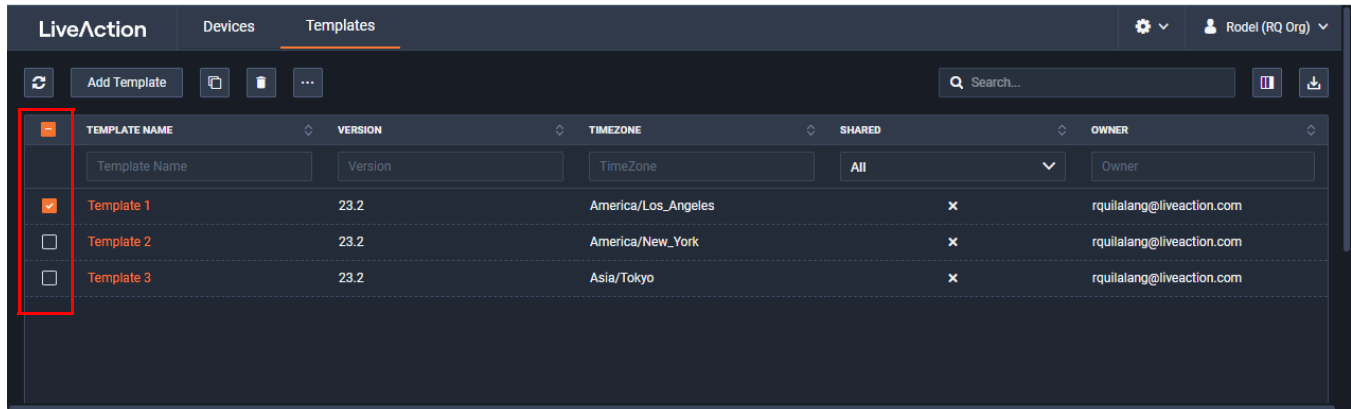

Devices column headings

Descriptions of the columns displayed in the list of templates are provided below.

Tip Below each of the column headings is either a text box or list box that you can use to filter the devices displayed in the list of Devices. To filter using the text box, simply enter a text string to display the devices that match the text string. To filter using a list box, click the box and select an option to display the devices that match that option.

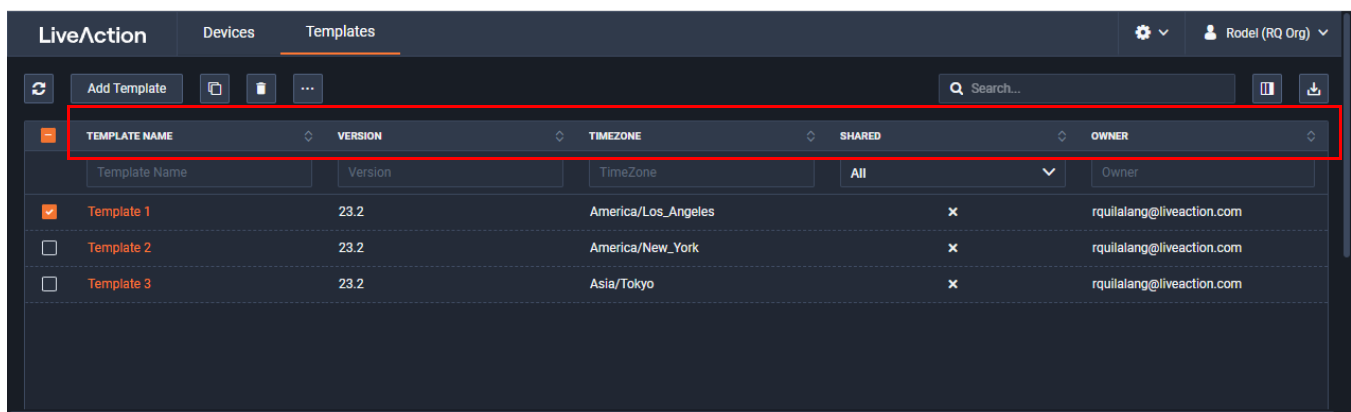

- *Template Name*: Displays the name of the template. Click the name to display details about the template.
- *Version*: Displays the version number of the template.
- *Timezone*: Displays the time zone of the template.
- *Shared*: Displays the users that have been shared with the device. Shared users can fully configure a device from Grid.

- **Owner.** Displays the owner of the device. There can only be one owner of the device.

Adding a template

Click *Add Template* to display the *Configure* settings to configure the new template.

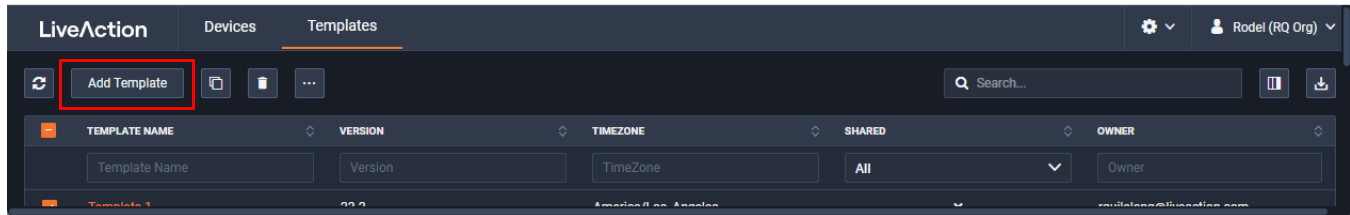

With the exception of the *Template Name* and *Template Version* settings, the settings available to configure templates are the same settings used to configure a device. Follow the links below for descriptions of the settings.

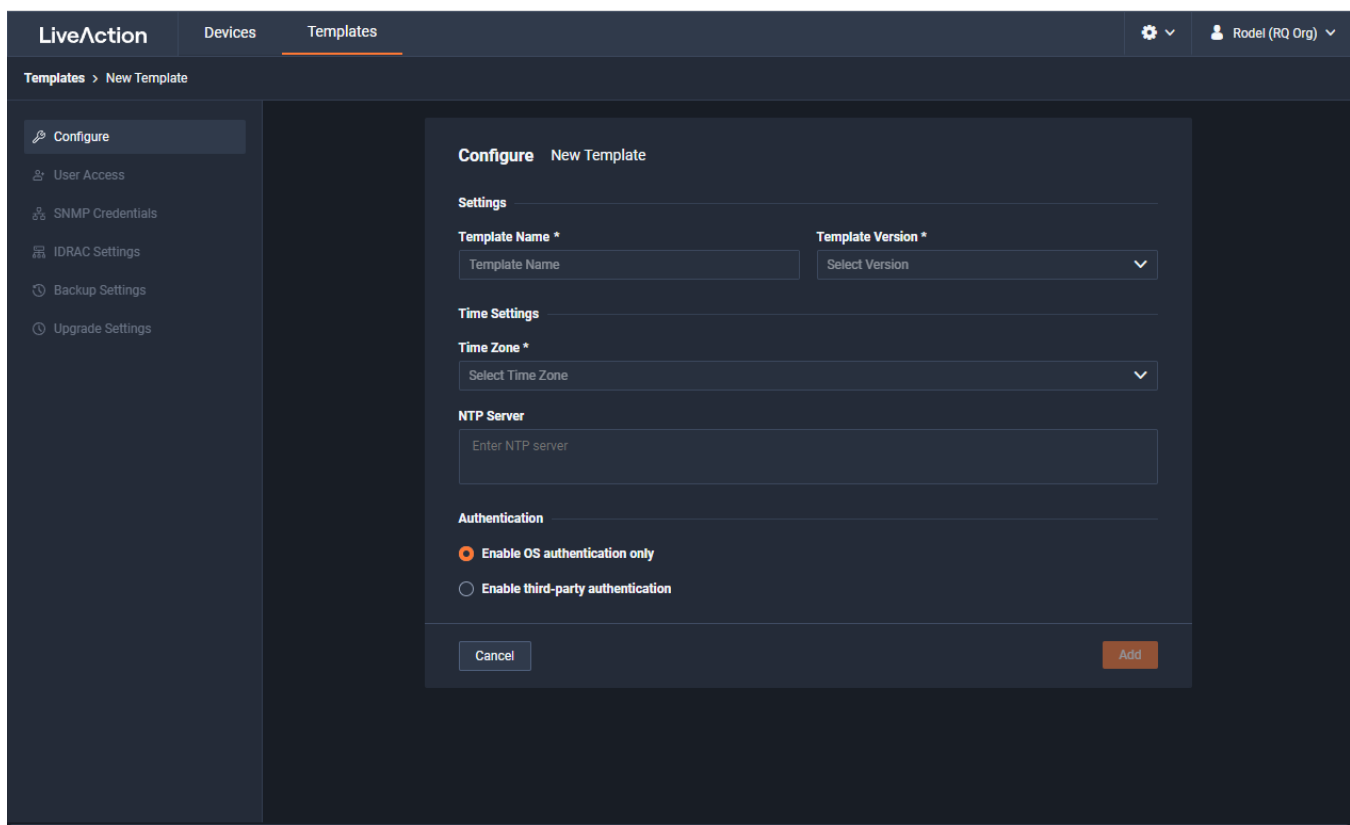

To add a new template:

1. Click the **Add Template** button to display the *Configure* dialog.
2. Configure the new template:
 - *Template Name*: Type a name for the template.
 - *Template Version*: Click to select the version of the template you are configuring.
 - *Time Settings*: See 'Time Settings' on page 58.
 - *Authentication*: See 'Authentication' on page 59.
3. Click **Add**. The new template is created and you will now have access to the options below in the left-hand pane to further configure settings for the template.

- *Configure*: See 'Configure' on page 55.
- *User Access*: See 'User Access' on page 60.
- *SNMP Credentials*: See 'SNMP Credentials' on page 61.
- *iDRAC Settings*: See 'iDRAC Settings' on page 62.
- *Backup Settings*: See 'Backup Settings' on page 64.
- *Upgrade Settings*: See 'Upgrade Settings' on page 67.

User Management

Select *User Management* to add or remove authorized users for your organization that have access to Grid. For each user, you can specify the roles that define the user's level of access to Grid.

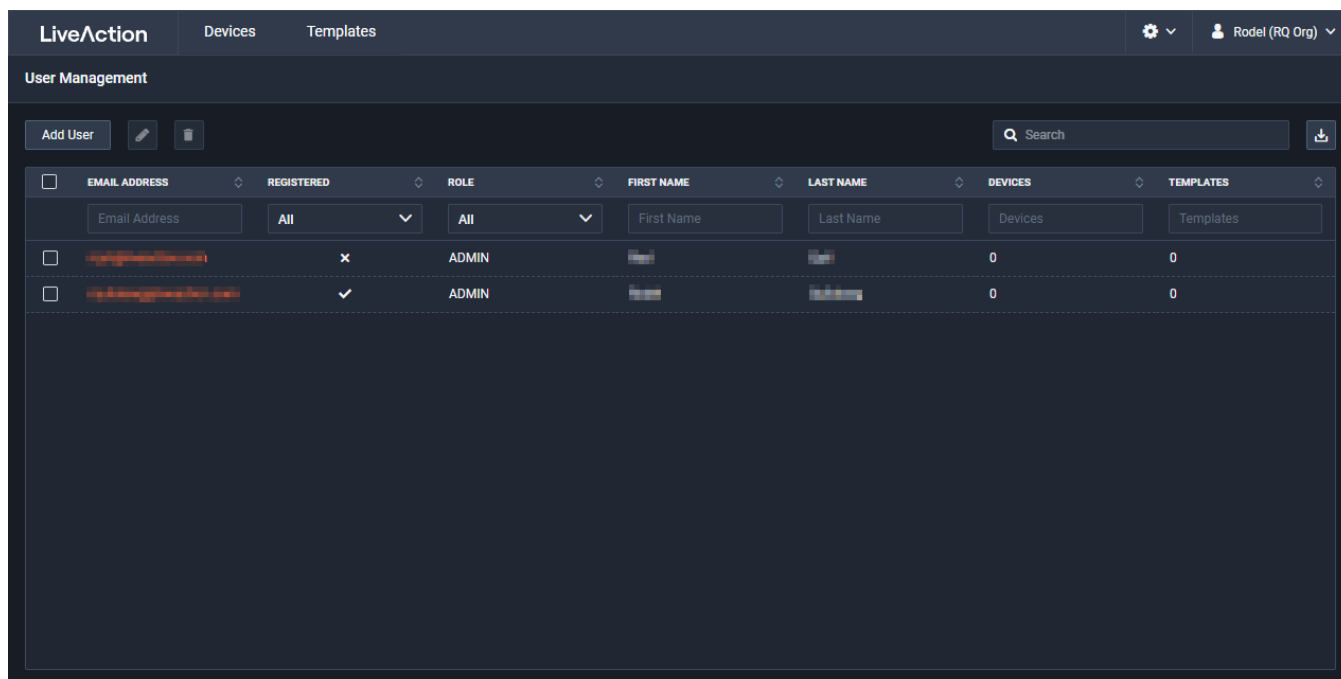
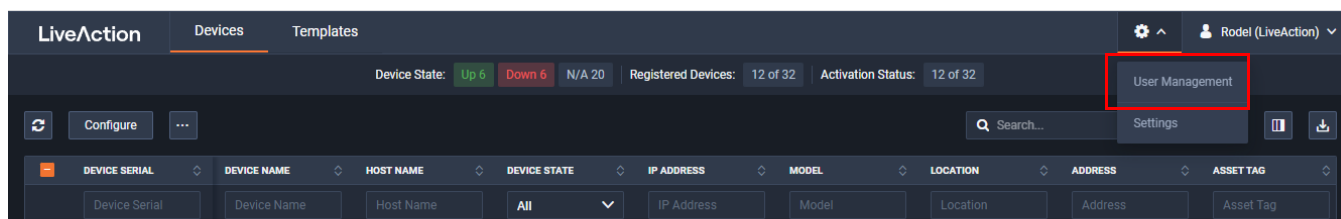

Add User

Click *Add User* to add an authorized user to have access to Grid.

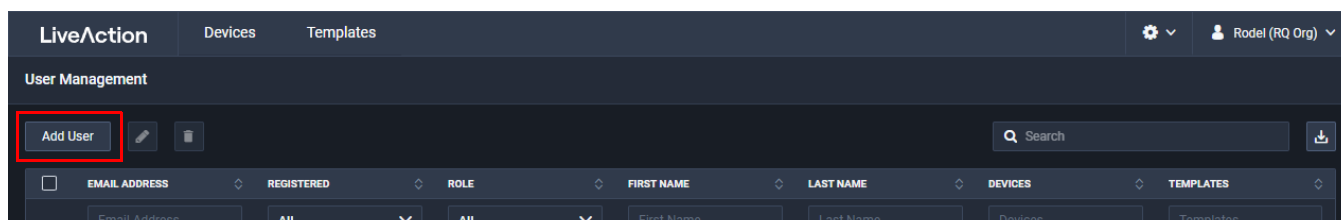

- *Email*: Type the email of the user.

- **Role:** Select the role assigned to the user. A user can be assigned the following roles:
 - **Admin:** Users in this role are able to view and modify/configure all devices and users that belong to the organization. Additionally they can add new users to the organization and are allowed to configure Single Sign On (SSO).
 - **Config:** Users in this role are able to view and configure any devices that have been shared to them by another user that has access. They cannot perform operations on user accounts or SSO.
 - **View:** Users in this role can only view devices that have been assigned to them and are not able to effect any changes within the system.
- **First Name:** Type of the first name of the user.
- **Last Name:** Type of the last name of the user.

Edit User

Click *Edit User* to edit the details of the selected user.

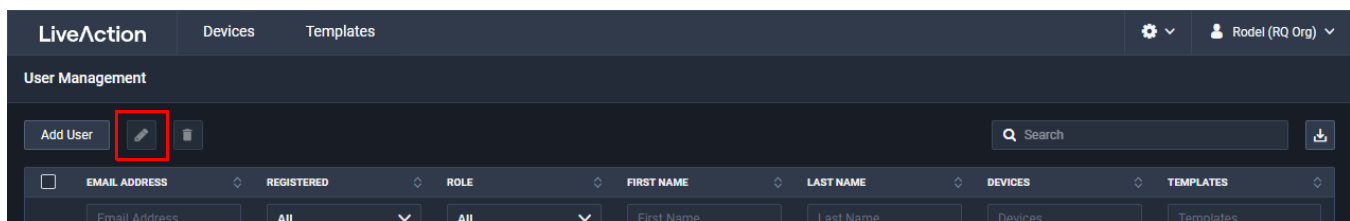

Delete User

Click Delete User to delete the selected user from the list of users.

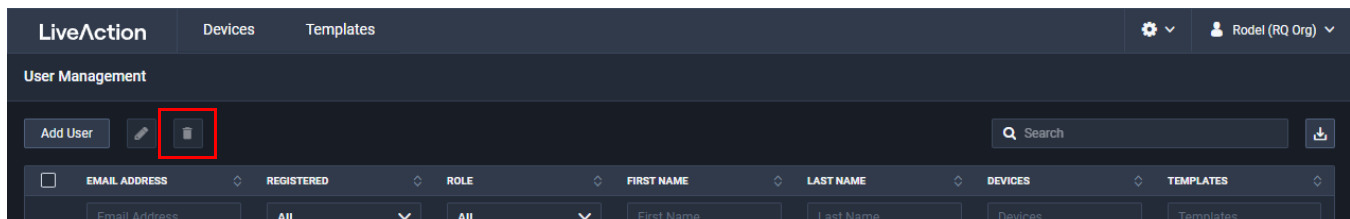

Search

Use the *Search* field to locate a specific user in the list of users. Simply enter a text string to display all users that match the text string.

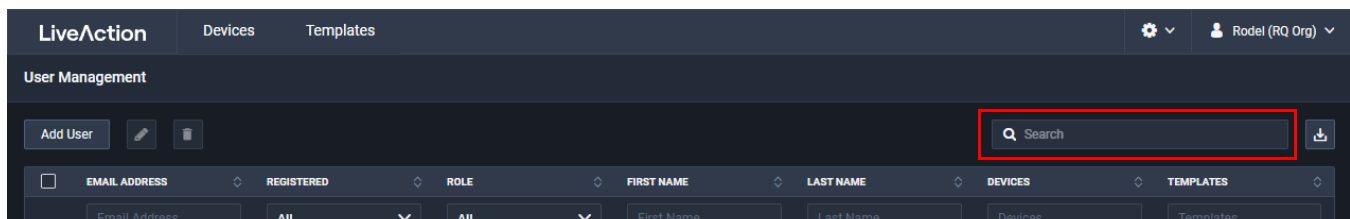

Download

Click *Download* to create and download a .csv file of the list of users.

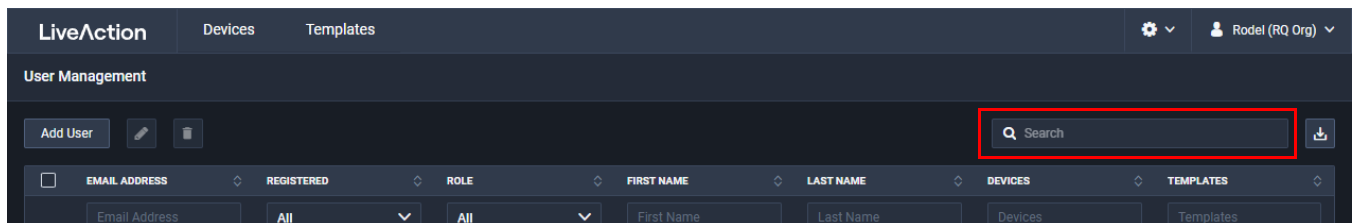

Check Box

To select a user in the list of users, select the check box of the desired users. Selecting the check box at the top of the column allows you to select or clear the check boxes of all users in the list of users.

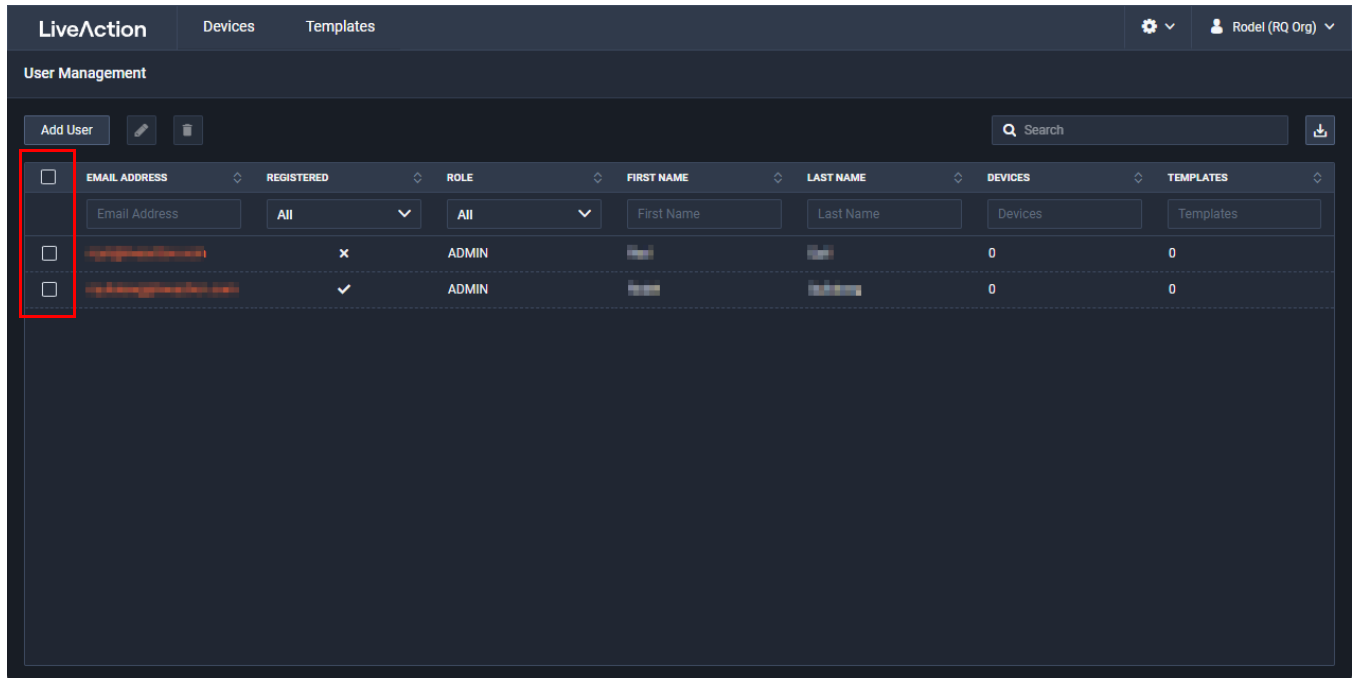

User Management Column Headings

The screenshot shows the 'User Management' section of the LiveAction interface. A table of users is displayed with the following column headings highlighted by a red box:

EMAIL ADDRESS	REGISTERED	ROLE	FIRST NAME	LAST NAME	DEVICES	TEMPLATES
Email Address	All	All	First Name	Last Name	Devices	Templates
[redacted]	✗	ADMIN	[redacted]	[redacted]	0	0
[redacted]	✓	ADMIN	[redacted]	[redacted]	0	0

- *Email Address*: Displays the email address of the user.
- *Registered*: Displays a check mark if the user has been registered with LiveAction. An X indicates the user is not registered with LiveAction.
- *Role*: Displays the role assigned to the user.
- *First Name*: Displays the first name of the user.
- *Last Name*: Displays the last name of the user.
- *Devices*: Displays the number of devices the user has registered.
- *Templates*: Displays the number of templates the user has defined.

Settings

Select *Settings* to configure Grid's *Single Sign On* settings.

The screenshot shows the 'Devices' section of the LiveAction interface. The 'Settings' button is highlighted with a red box. The interface also displays device status information:

Device State: Up 6 Down 6 N/A 20 Registered Devices: 12 of 32 Activation Status: 12 of 32

The table below shows the column headings for the device list:

DEVICE SERIAL	DEVICE NAME	HOST NAME	DEVICE STATE	IP ADDRESS	MODEL	LOCATION	ADDRESS	ASSET TAG
Device Serial	Device Name	Host Name	All	IP Address	Model	Location	Address	Asset Tag

Single Sign On

The *Single Sign On* settings allows you to use an organization's identity provider (e.g. Okta, Ping, Auth0, etc.) for authentication.

- *Enable Single Sign On*: Click to enable or disable Single Sign On.
- *Identify Provider SSO URL*: Enter the *Single Sign On Service (Ping)* or *Idp Single Sign-On URL (Okta)*.
- *Entity ID/Application Callback URL*: Enter the *ACS URL (Ping)* or *Assertion Consumer Service (ACS) URL (Okta)*.
- *Identify Provider Entity ID/Issuer*: Enter *Issuer ID (Ping)* or *IdP Issuer URI (Okta)*.
- *Consumer Logout URL*: Enter the *SLO Endpoint (Ping)*.
- *Certificate*: Enter the *Signing Certificate (Ping)* or *IdP Signature Certificate (Okta)*.
- *Reset*: Click to reset the *Single Sign On* settings.
- *Save*: Click to save the *Single Sign On* settings.

Note The *Consumer Logout URL* and *Application Callback URL* settings in Grid are generated by Grid after you save the *Single Sign On* settings.

Change Password

Select *Change Password* to change the password for logging into Grid.

Configure the *Change Password* dialog to change the password of Grid.

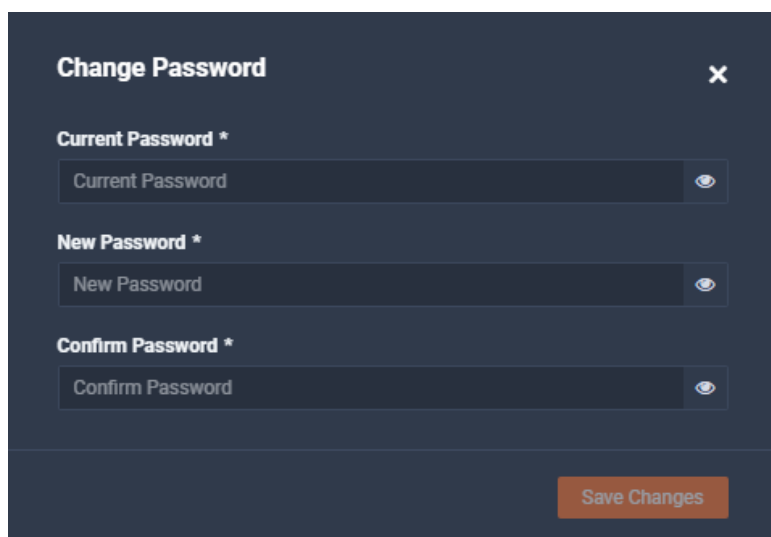

Change Password ✕

Current Password *

Current Password 👁

New Password *

New Password 👁

Confirm Password *

Confirm Password 👁

Save Changes

- *Current Password*: Enter the current password.
- *New Password*: Enter the new password. The new password must meet the following requirements:
 - Must have 5 different characters than the last password.
 - Must be at least 6 characters.
 - Must contain at least 1 number
 - Must contain at least 1 uppercase character.
 - Must contain at least 1 lowercase character.
 - Must contain at least 1 special character.
- *Confirm Password*: Enter the new password again.
- *Save Changes*: Click to apply the new password for Grid.

About

Select *About* to view the *Application version* of Grid.

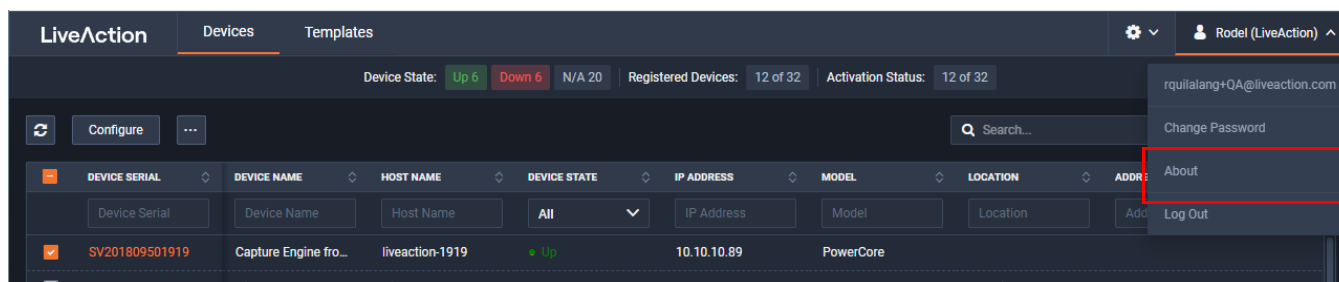

LiveAction Devices Templates ⚙ Rodel (LiveAction) ^

Device State: Up 6 Down 6 N/A 20 Registered Devices: 12 of 32 Activation Status: 12 of 32

Configure ⋮ Search... rqilalang+QA@liveaction.com

Change Password

About

Log Out

DEVICE SERIAL	DEVICE NAME	HOST NAME	DEVICE STATE	IP ADDRESS	MODEL	LOCATION	ADDRESS
SV201809501919	Capture Engine fro...	liveaction-1919	Up	10.10.10.89	PowerCore		

Log Out

Select *Log Out* to log out of Grid.

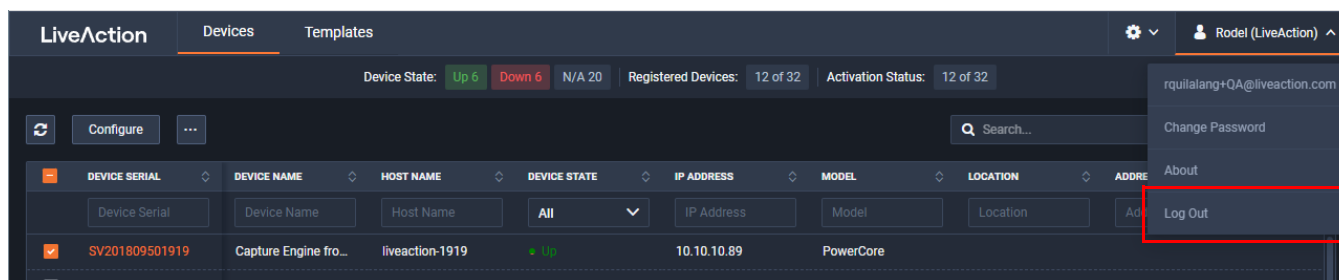

LiveAction Devices Templates ⚙ Rodel (LiveAction) ^

Device State: Up 6 Down 6 N/A 20 Registered Devices: 12 of 32 Activation Status: 12 of 32

Configure ⋮ Search... rqilalang+QA@liveaction.com

Change Password

About

Log Out

DEVICE SERIAL	DEVICE NAME	HOST NAME	DEVICE STATE	IP ADDRESS	MODEL	LOCATION	ADDRESS
SV201809501919	Capture Engine fro...	liveaction-1919	Up	10.10.10.89	PowerCore		

Backup and restore

The *Backup Settings* in Grid let you configure and designate either an *SFTP* (Secure FTP) server or *Cloud Backup* for backing up the application and system settings on the LiveWire device. Once a backup is created, you can use the *Restore Backup* settings to restore either the application settings, or both the application and system settings to the same or different LiveWire device.

Here are descriptions of the *Application* and *System* settings that are included in a backup:

- *Application* settings: These are all application settings and customizations, including capture templates, filters, graphs, alarms, notifications, name table, SSL certificates, and custom plugins.
- *System* settings: These are new and/or updated users, SNMP, NTP, network, time zone, and host customizations.

Creating a backup

1. Click the **Elipsis (...)** in Grid and select *Backup Settings*. The *Backup Settings* dialog appears. See 'Backup Settings' on page 64 for a description of each of the settings.

The screenshot shows the 'Backup Settings' dialog for device 12345. The 'Destination' section has 'Cloud Backup' selected. The 'Encryption' section shows 'Status: Not Configured' with a 'Configure Encryption' button. The 'Schedule' section has 'Backup Filename prefix' set to 'Backup Filename prefix', 'Backup Interval' set to 7 days, and 'Retention Limit' set to 5 backups. The 'GMT Date and Time' is set to 8/10/2023 at 12:22. Buttons for 'Cancel', 'Revert', and 'Apply' are at the bottom.

2. In the *Destination* section, choose one of the following:
 - *SFTP*: Select this option to back up to the SFTP (Secure FTP) server. You will need to configure the SFTP server you want to use as the backup server.
 - *Cloud Backup*: Select this option to back up to Grid Cloud Storage.
3. In the *Encryption* section, click *Configure Encryption* to set up encryption.
4. In the *Schedule* section, configure the *Schedule* settings.
5. Click **Apply**.

Restoring a backup

1. Click the **Elipsis (...)** in Grid and select *Restore Backup*. The *Restore Backup* dialog appears. See 'Restore Backup' on page 66 for a description of each of the settings.

The screenshot shows the 'Restore Backup' dialog for a Capture Engine (LA202111600180). The dialog has a sidebar on the left with various configuration options, and a main area with a table of backup actions. The table has the following columns: ACTION, STATUS, FILE NAME, BACKUP TIME, and LOCATION. The first row is highlighted in orange, indicating it is selected for restoration. The table contains the following data:

ACTION	STATUS	FILE NAME	BACKUP TIME	LOCATION
Restore	Success	config-ia180fromDMS_chris...	2023-08-10T14:00:25.747Z	10.0.0.248/upload/config-l...
Restore	Failed		2023-08-10T04:31:35.556Z	
Restore	Failed		2023-08-09T04:31:35.556Z	
Restore	Failed		2023-08-08T16:06:54.140Z	
Restore	Failed		2023-08-08T04:31:54.139Z	
Restore	Success	config-ia180fromDMS_chris...	2023-08-07T16:06:25.467Z	10.0.0.248/upload/config-l...
Restore	Deleted	config-ia180fromDMS_chris...	2023-08-07T16:06:25.023Z	10.0.0.248/upload/config-l...
Restore	Deleted	config-ia180fromDMS_chris...	2023-08-06T16:06:23.216Z	10.0.0.248/upload/config-l...
Restore	Failed		2023-08-05T16:06:54.394Z	
Restore	Failed		2023-08-05T16:06:54.188Z	

2. In the *Action* column, select the backup (in orange) you want to restore.
3. Select either the *Application Settings* or *Application and System Settings* option, enter the *Password* for the backup, and click **Restore**.

Configuring network settings by command script

You can configure LiveWire network settings by using the 'omni-interface' command script from the 'root' user command prompt (*root@LiveWire*). To get to the 'root' user command prompt, enter the following command from the command prompt and enter '**admin**' as the password when prompted:

```
#sudo su
```

Note There are numerous ways to log into the LiveWire command prompt for LiveWire. See 'Logging-in to LiveWire command line' on page 32.

Here are the commands to configure the network settings from the command prompt:

Usage: *omni-interface [options]*

Example (IP configuration): *omni-interface -a eth0 -s -r x.x.x.x -m x.x.x.x -g x.x.x.x -d x.x.x.x*

options:

<code>-a, --adapter</code>	adapter to modify
<code>-f, --wifi</code>	enable or disable Remote AP Capture capability [on off]
<code>-c, --dhcp</code>	configure dhcp
<code>-s, --static</code>	configure static
<code>-l, --manual</code>	configure manual
<code>-r, --address</code>	static adapter address
<code>-m, --netmask</code>	static adapter netmask
<code>-b, --broadcast</code>	static adapter broadcast address
<code>-w, --network</code>	static adapter network address
<code>-g, --gateway</code>	static adapter gateway address
<code>-h, --hwaddress</code>	static adapter mac address
<code>-d, --dns</code>	static dns servers (comma separated)

Important! The Ethernet ports can be configured to obtain an IP address automatically from a DHCP server by specifying 'dhcp' instead of 'static' settings; however, we strongly recommend the use of static IP addresses for the Ethernet ports. If DHCP is used, and if the address should change on a new DHCP lease, then the user must restart the Capture Engine service to see the new IP addresses in the 'Adapters' capture options in Omnippeek.

Additionally, if you specify 'dhcp' instead of 'static' settings, and there is no DHCP server available, you must allow the command to time-out.

Using LiveWire with Omnippeek

Any computer on the network with the Omnippeek Windows software installed can now access the Capture Engine running on LiveWire. From the **Capture Engine** window in Omnippeek, you can configure, control, and view the results of the Capture Engine remote captures.

For more information on how to view and analyze remote captures from within the Omnippeek console, please see 'Using Capture Engines with Omnippeek' on page 115, and also the *Omnipeek User Guide* or Omnippeek online help.

Integrated Remote Access Controller (iDRAC)

The Integrated Remote Access Controller (iDRAC) firmware and hardware built into LiveWire (LiveWire Core/PowerCore only) lets you remotely access LiveWire as if you were in the same room as the LiveWire. Using an Internet browser, you can easily perform tasks such as accessing a remote console, reimaging LiveWire, rebooting, shutting down, and starting LiveWire (even if LiveWire is off). See also XXX for LiveWire StorageCore.

iDRAC and network security

iDRAC is a powerful tool for performing various tasks remotely on LiveWire; however, there are potential network security vulnerabilities when using iDRAC.

Below are some suggestions to ensure that vulnerabilities through iDRAC are minimized:

- **Restrict iDRAC to Internal Networks:** Restrict iDRAC traffic to trusted internal networks. Traffic from iDRAC (usually UDP port 623) should be restricted to a management VLAN segment with strong network controls. Scan for iDRAC usage outside of the trusted network, and monitor the trusted network for abnormal activity.
- **Utilize Strong Passwords:** Make sure the iDRAC password on LiveWire is set to a strong, unique password. See 'Changing the default password' on page 87.
- **Encrypt Traffic:** Enable encryption on iDRAC, if possible. For example, use HTTPS in your web browser's URL location field when connecting to iDRAC (e.g., 'https://xxx.xxx.xxx.xxx').

Setting the IP address for iDRAC

iDRAC on LiveWire requires its own IP address for communication. You can set this in one of two ways:

- Access the BIOS settings for LiveWire and configure the IP address
- Use CLI commands from the command prompt and configure the IP address

Access BIOS setting to configure IP address

You must be physically present at LiveWire to initially set the iDRAC IP address. Once set, you can use iDRAC to view or change the setting.

To initially set the iDRAC IP address:

1. Locate the iDRAC port on the front or back of LiveWire, and connect an Ethernet cable from your network to the iDRAC port.
2. Reboot or restart LiveWire.
3. Press the [F2] key multiple times during system boot to enter the BIOS settings.
4. Select *iDRAC Settings* from the Advanced menu.
5. Select *Network* from the iDRAC submenu.
6. iDRAC is set to 192.168.1.21 by default. You can change the static address as well. You will need this IP address in order to remotely access LiveWire.
7. Press [Esc] to back out of each menu, then press **Enter** to confirm exit.

Connecting to iDRAC on LiveWire

You can use an Internet browser window to connect to iDRAC on LiveWire. Additionally, you must make sure the following ports are accessible through any firewall:

- Port 80 (TCP)
- Port 443 (Web HTTP SSL)

- Port 623 (UDP)
- Port 5901 (Video)
- Port 5900 (Keyboard/Mouse)
- Port 5120 (Media Redirection)

To connect to iDRAC on LiveWire using your browser:

1. From a computer connected to the network, open an Internet browser window.
2. Enter the iDRAC IP address of LiveWire in the address bar of your browser.
3. Once the connection is made, the Login screen appears.

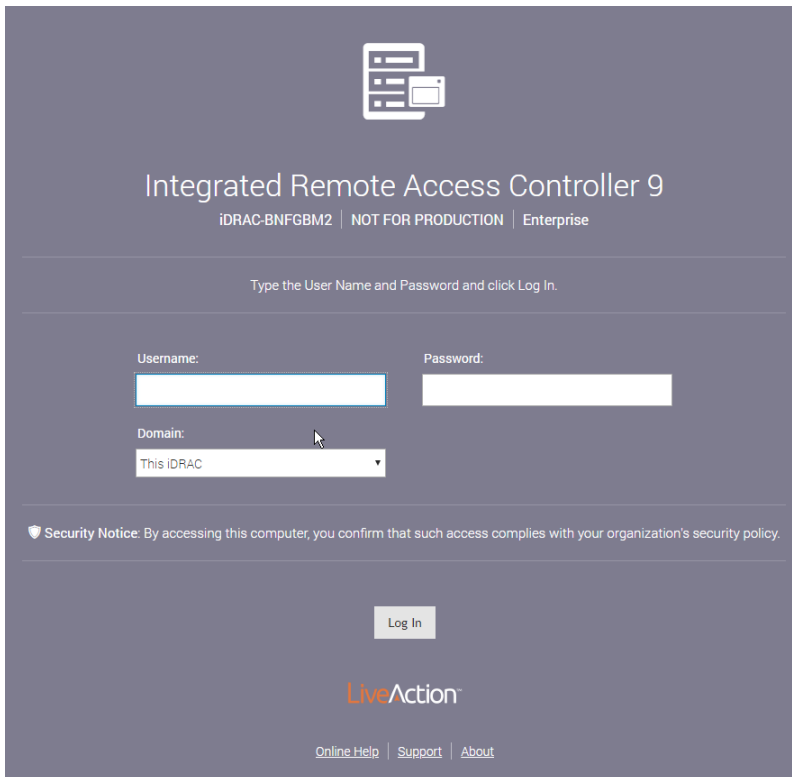

4. Enter the *Username* and *Password*, and then click **Login** (the default username is **root**, and the default password is **liveaction**). The iDRAC dashboard appears.

Note For security reasons, we strongly recommend changing both the default iDRAC username and password on LiveWire.

The screenshot shows the iDRAC Enterprise Dashboard. At the top, there's a header with 'Integrated Remote Access Controller 9 | Enterprise' and user information. Below the header, there are three tabs: 'Graceful Shutdown', 'Identify System', and 'More Actions'. The main content area is divided into several sections:

- System Health:** A grid of status indicators for Batteries, CPUs, Cooling, Intrusion, Memory, and Power Supplies, all showing green checkmarks.
- System Information:** A list of system details including Power State (ON), Model (NOT FOR PRODUCTION), Host Name (localhost.localdomain), Operating System (Ubuntu), Operating System Version (14.04, Trusty Tahr Kernel 3.13.0-143-generic (x86_64)), Service Tag (BNFGBM2), BIOS Version (1.3.7), iDRAC Firmware Version (3.15.17.15), and iDRAC MAC Address (d0:94:66:25:8b:83).
- Virtual Console:** A section with a 'Launch Virtual Console' button and a 'Settings' link.
- Recent Logs:** A table with columns for Severity, Description, and Date and Time. It shows three log entries related to chassis power states.
- Notes:** A section with an 'add note' button and a 'view all' link. It currently shows no notes.

- View the remaining instructions in this section for instructions on using iDRAC to perform tasks such as changing the default password, accessing a remote console, reimaging, rebooting, starting, and shutting down LiveWire.

Changing the default password

For security reasons, we strongly recommend changing both the default username and password to iDRAC.

To change the default password:

- In the iDRAC Settings, click *Users*. The list of *Local Users* appears.

The screenshot shows the iDRAC Settings page. The 'Users' tab is selected, and the 'Local Users' section is expanded. Below the section title, there are buttons for 'Details', '+ Add', 'Edit', 'Disable', and 'Delete'. A table lists the local users:

ID	User Name	State	User Role	IPMI LAN Privilege	IPMI Serial Privilege	Serial Over LAN	SNMP v3
2	root	Enabled	Administrator	Administrator	Administrator	Enabled	Disabled
3	ADMIN	Enabled	Administrator	Administrator	Administrator	Enabled	Disabled

Below the table, there are expandable sections for 'Directory Services', 'Smart Card', 'Default Password Warning', and 'Sessions'.

- Select the *User ID* of the user you are configuring (in this case, user ID 2), and click **Edit**. The **User Account Settings** dialog for the selected user ID appears.

- Make your edits to the *User Name* and *Password* settings, and then click **Save**.

Accessing a remote console

A powerful feature when using iDRAC is the ability to open a remote console from which you can enter commands to LiveWire.

To open a remote console:

Note The *Plug-in Type* was changed to 'HTML5' from the default of 'Native' for the instructions in this section. To change the *Plug-in Type*, click *Settings* in the *Virtual Console Preview*.

- From the iDRAC dashboard, click *Launch Virtual Console*. The LiveWire login window appears.

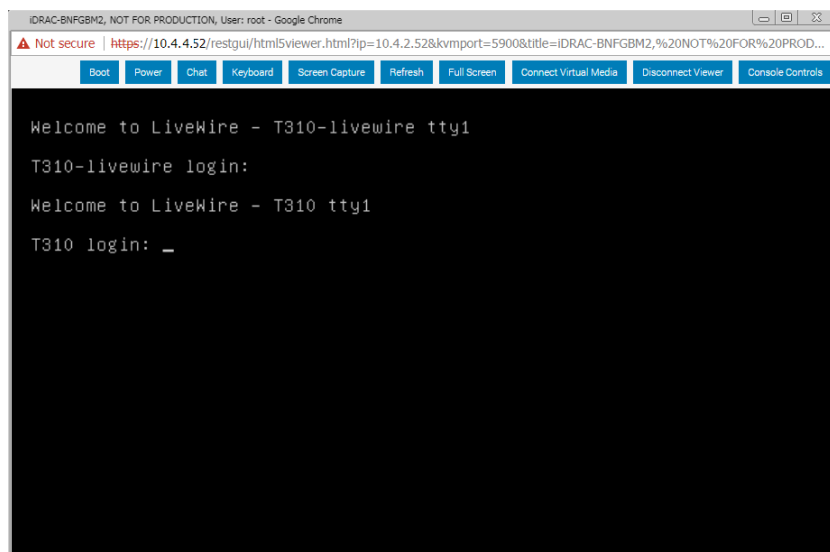

- Log into LiveWire using LiveWire login user name and password. The `admin@livewire:~#` command prompt appears once you are logged into LiveWire.

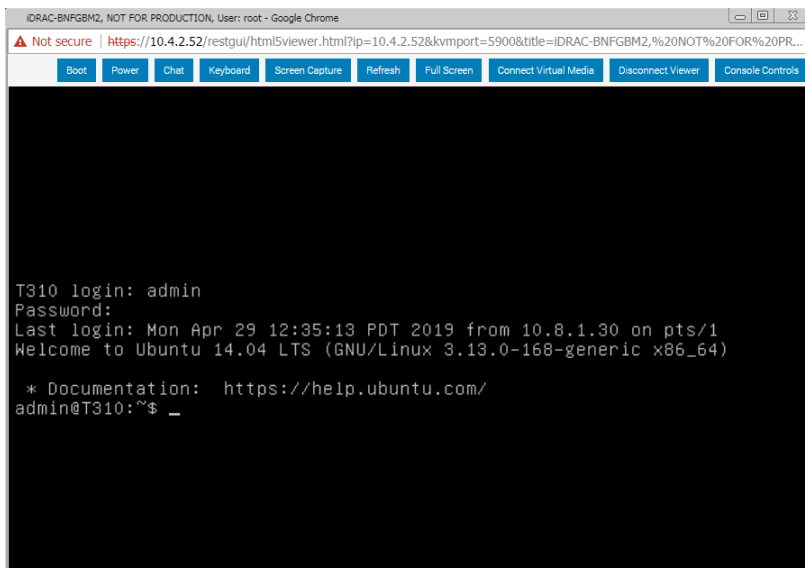

```

IDRAC-BNFG8M2, NOT FOR PRODUCTION, User: root - Google Chrome
Not secure | https://10.4.2.52/restgui/html5viewer.html?ip=10.4.2.52&kvmport=5900&title=IDRAC-BNFG8M2,%20NOT%20FOR%20PR...
Boot Power Chat Keyboard Screen Capture Refresh Full Screen Connect Virtual Media Disconnect Viewer Console Controls

T310 login: admin
Password:
Last login: Mon Apr 29 12:35:13 PDT 2019 from 10.8.1.30 on pts/1
Welcome to Ubuntu 14.04 LTS (GNU/Linux 3.13.0-168-generic x86_64)

 * Documentation:  https://help.ubuntu.com/
admin@T310:~$ _

```

Reimaging LiveWire with an ISO image

You can reimage LiveWire remotely using iDRAC and an ISO image available from LiveAction technical support. See 'Contacting LiveAction support' on page 30.

To reimage LiveWire:

1. From the remote console, click **Connect Virtual Media**. The **Virtual Media** dialog appears.

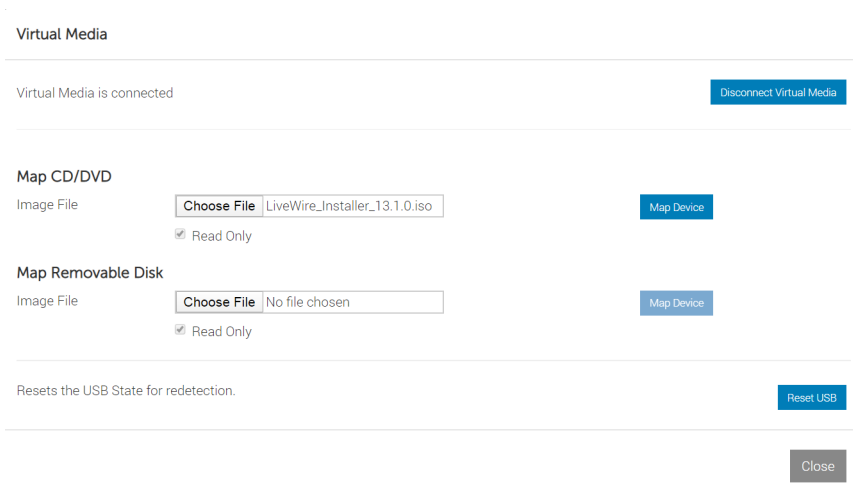

Virtual Media

Virtual Media is connected Disconnect Virtual Media

Map CD/DVD

Image File Map Device

Read Only

Map Removable Disk

Image File Map Device

Read Only

Resets the USB State for redetection. Reset USB

Close

2. Click **Choose File** under *Map CD/DVD* to select the ISO file (e.g., *omni-20.1.0-x.iso*), and then click **Map Device**. The ISO image is mapped to the CD/DVD drive.

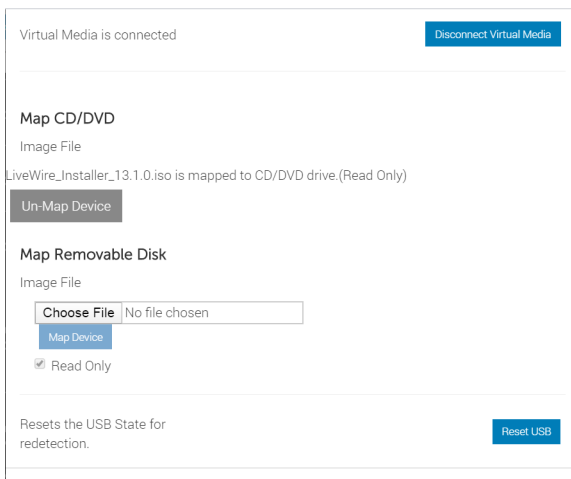

3. Click **Close** to close the dialog.
4. From the remote console, click **Boot** and select *Virtual CD/DVD/ISO* from the boot controls. The **Confirm Boot Action** dialog appears.

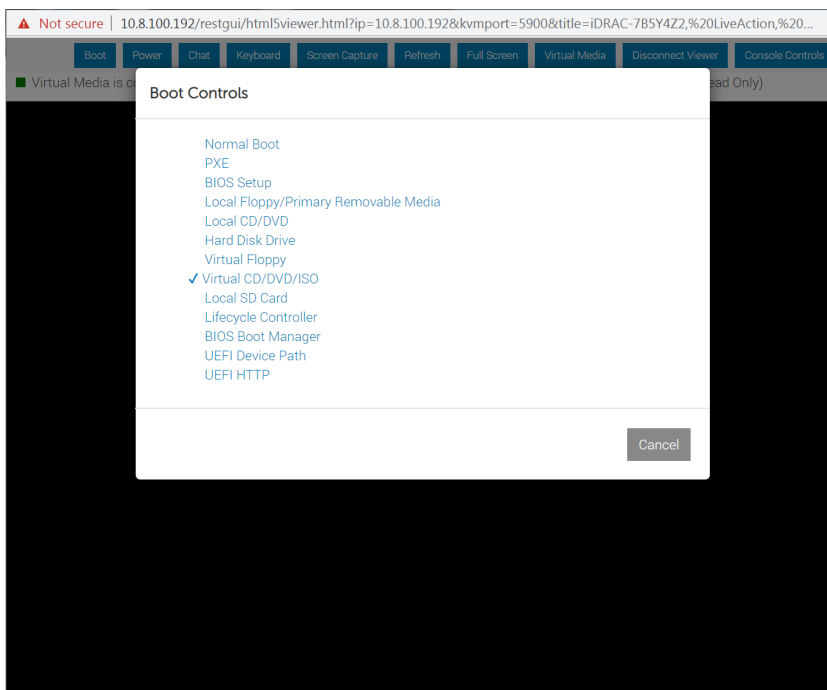

5. Click **Yes** to set the *Virtual CD/DVD/ISO* as the new boot device.

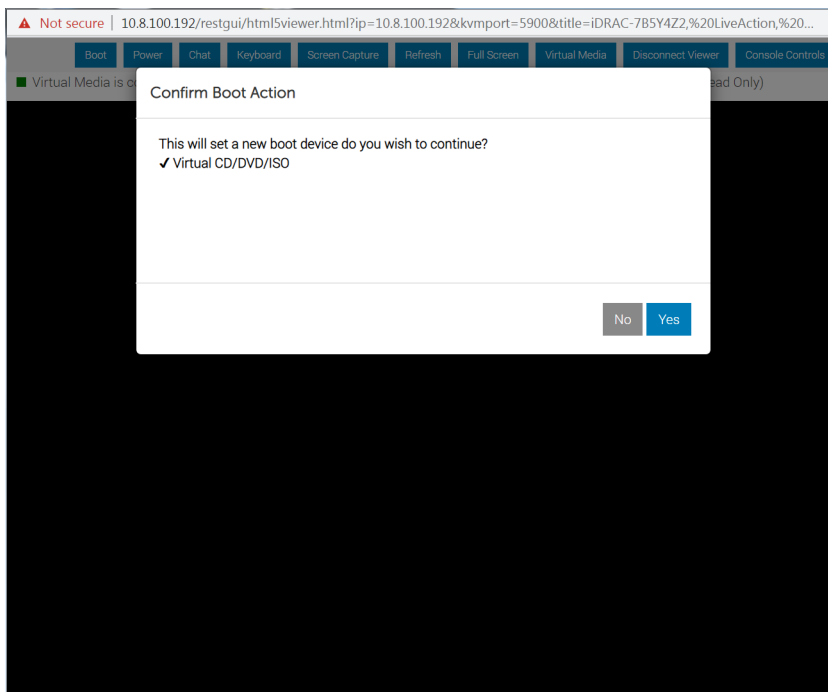

6. From the remote console, click **Power** and select *Power Cycle System (cold boot)*. The **Confirm Power Action** dialog appears.
7. Click **Yes** to execute the *Power Cycle System (cold boot)*.
8. Click **OK** to confirm, and the system will start to load the ISO image. Allow the system to fully boot from the ISO image.
9. Once the ISO image is fully loaded, you are prompted to log into the boot ISO image. Log in using the username ('root') and password ('liveaction').
10. At the command prompt, type *livewire-install* and press **Enter**. You will receive a warning message that all data will be lost.

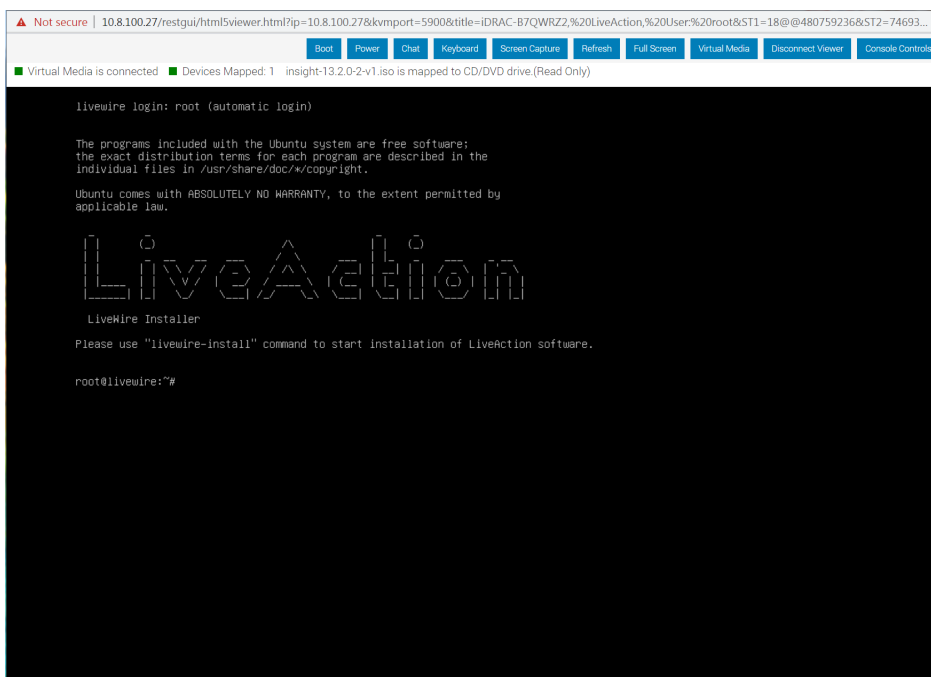

11. Type **Yes** and press **Enter**. The install process takes up to 20 minutes.

Note When running the `livewire-install` script through the remote console, do not close the console until the script completes. Closing the console prematurely causes the reimaging process to fail.

12. When the install process is finished, type `reboot` and press **Enter**. You will receive instructions to eject any disc.
13. Click the Power button again and select **Reset System (warm boot)**.
14. Once LiveWire has rebooted, you can proceed to configuring the management IP, time zone, NTP, and other settings for LiveWire as you normally would. See those sections in this guide for instructions.

Rebooting LiveWire

To reboot LiveWire:

- From the remote console, click **Boot** and select *Normal Boot* from the boot controls and follow the prompts to reboot.
- From the remote console, enter the `reboot` command.

```

usage: sudo -e [-AknS] [-r role] [-t type] [-C num] [-g group] [-h host] [-p prompt] [-T timeout] [-u user] file ...
root@livewire:~# sudo su
root@livewire:~# livewire-install
LiveWire i3.2.0-2-v1 installation script
This will erase all data on the hard drive
Would you like to continue? (Yes/No) [No]: yes
Turning off swaps... OK
Configuring hardware raid... OK
Probing drives... OK
Selecting boot drive: sda - 3814912 MB
Selecting var drive: sdb - 3814912 MB
Selecting data drive(s):
Data drive: sda - 3814912 MB
Data drive: sdb - 3814912 MB
Data drive: sdc - 3814912 MB
Data drive: sdd - 3814912 MB
Unmounting all partitions of sda
Unmounting all partitions of sdb
Unmounting all partitions of sdc
Unmounting all partitions of sdd
Deleting all existing partitions on boot drive
Clear all existing partitions
Creating a new partition table on sda
Deleting all existing partitions on data drive - sdb
Clear all existing partitions
Creating a new partition table on sdb
Deleting all existing partitions on data drive - sdc
Clear all existing partitions
Creating a new partition table on sdc
Deleting all existing partitions on data drive - sdd
Clear all existing partitions
Creating a new partition table on sdd
Creating new partitions...
parted -s /dev/sda set 1 esp off
parted -s /dev/sda set 1 bios_grub on
Creating lvm on data partitions...
Creating filesystem on /dev/sda2... OK
Creating swap volume on /dev/sdb2... OK
Creating filesystem on /dev/sdb1... OK
Creating filesystem on /dev/data/raid0... OK
Mounting /dev/sda2
Setting up grub... OK
Copying system image files to /dev/sda2... OK
Unpacking system image files: OK
Updating boot menu: OK
Configuring DELL iDRAC... OK
Done!
root@livewire:~# reboot

```

Starting / Shutting down LiveWire

If your power cables and Ethernet cable are connected to LiveWire, you can access iDRAC even if LiveWire is off. Once iDRAC is accessed, you can use iDRAC to start LiveWire.

To start or shut down LiveWire:

- From the iDRAC dashboard, if LiveWire is off click *Power On System*, or *Graceful Shutdown* if it is on.

Note If you have a remote console open, you can also select the start or power off commands from the **Power** menu of the remote console.

You can also issue the `#poweroff` command (recommended) from the remote console to shut down LiveWire.

Accessing the iDRAC interface over the USB port

The iDRAC direct feature allows you to directly connect your laptop to the iDRAC micro-USB port on LiveWire using a USB to micro-USB cable. The location of the iDRAC micro-USB port is found in the right control panel on the front of LiveWire.



iDRAC micro-USB port



USB to micro-USB cable

To access the iDRAC interface:

1. Turn off any wireless networks and disconnect from any other hard wired network.
2. Ensure that the USB port is enabled in your system BIOS settings (*System BIOS > Integrated Devices*).
3. Use a USB to micro-USB cable and connect your laptop to the iDRAC micro-USB port on LiveWire.
4. After you connect the micro-USB cable to the laptop, the laptop will download the “iDRAC Virtual NIC USB Device” driver automatically.

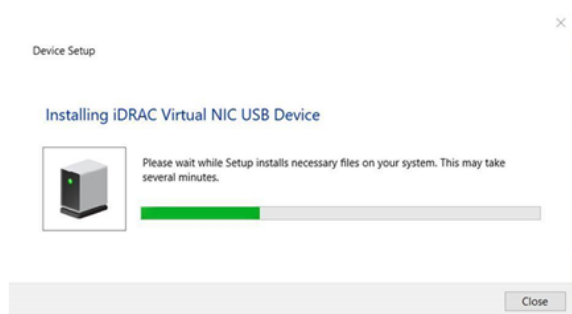

You will see *Remote NDIS Compatible Device #2* appearing in *Network adapters* in Device Manager.

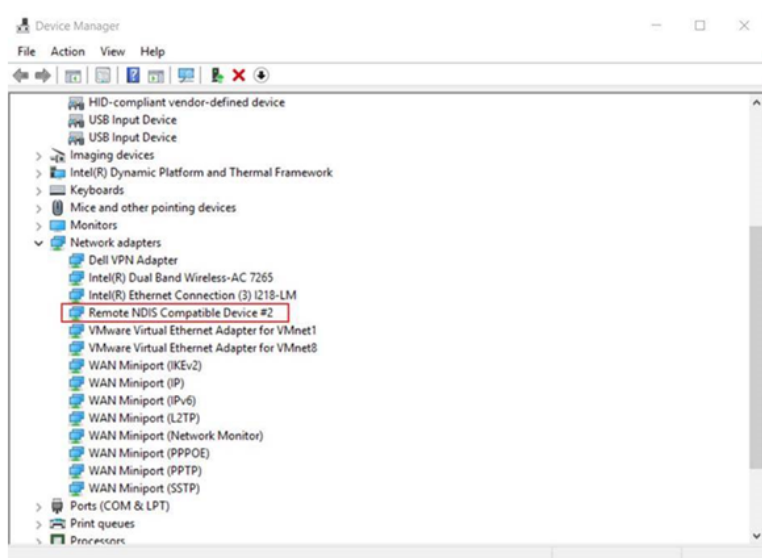

5. Wait for the laptop to obtain the IP address 169.254.0.4. It is always the same IP address. It may take several seconds for the IP addresses to be acquired. iDRAC acquires the IP address 169.254.0.3.

To check if the iDRAC is responding, issue the ping command.

```
C:\Users\>ping 169.254.0.3 -t

Pinging 169.254.0.3 with 32 bytes of data:
Reply from 169.254.0.3: bytes=32 time<1ms TTL=64
Reply from 169.254.0.3: bytes=32 time<1ms TTL=64
Reply from 169.254.0.3: bytes=32 time<1ms TTL=64
Reply from 169.254.0.3: bytes=32 time<1ms TTL=64
Reply from 169.254.0.3: bytes=32 time<1ms TTL=64
Reply from 169.254.0.3: bytes=32 time<1ms TTL=64
Reply from 169.254.0.3: bytes=32 time<1ms TTL=64
Reply from 169.254.0.3: bytes=32 time<1ms TTL=64
Reply from 169.254.0.3: bytes=32 time<1ms TTL=64
Reply from 169.254.0.3: bytes=32 time<1ms TTL=64
Reply from 169.254.0.3: bytes=32 time<1ms TTL=64
Reply from 169.254.0.3: bytes=32 time<1ms TTL=64
Reply from 169.254.0.3: bytes=32 time<1ms TTL=64
Reply from 169.254.0.3: bytes=32 time<1ms TTL=64
Reply from 169.254.0.3: bytes=32 time<1ms TTL=64
Reply from 169.254.0.3: bytes=32 time<1ms TTL=64
Reply from 169.254.0.3: bytes=32 time<1ms TTL=64
```

6. You can now start using the iDRAC network interfaces. For example, to access the iDRAC web interface, open a supported browser, and type the address 169.254.0.3 and press **Enter**. The iDRAC login screen appears.

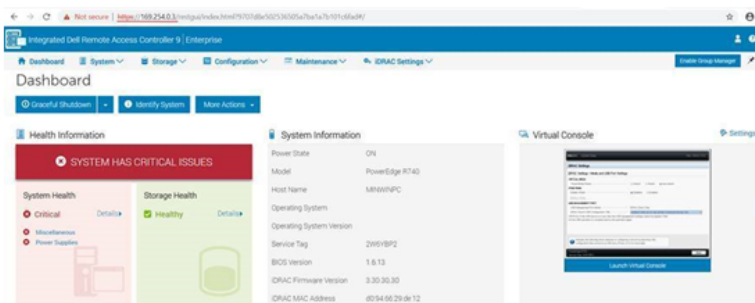

7. When iDRAC is using the USB port, the LED on LiveWire blinks indicating activity. The blink frequency is 4 per second. After completing the desired actions, disconnect the micro-USB cable from LiveWire. The LED turns off.

8. If the micro-USB cable can't be recognized, please navigate to *iDRAC Settings > Media and USB Port Settings > iDRAC Direct Only*.

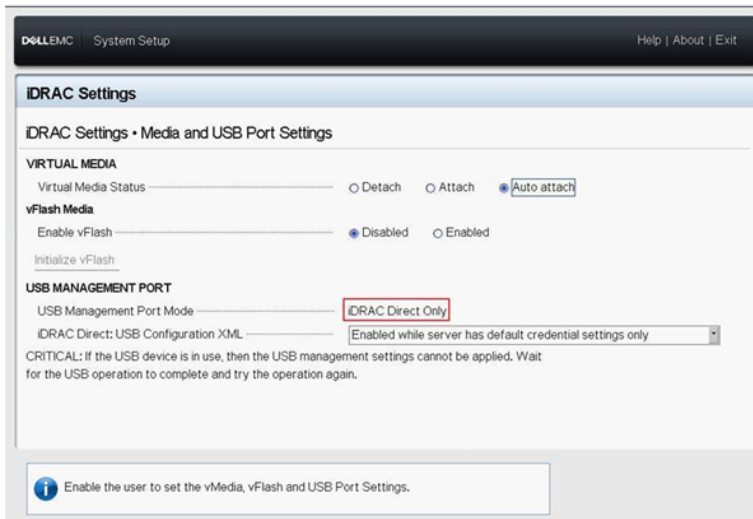

Sending LiveFlow Telemetry

In this chapter:

<i>About sending telemetry to LiveNX and other platforms</i>	97
<i>Configuring LiveFlow telemetry</i>	97
<i>An example of using LiveWire, LiveNX, and Omnipeek</i>	115

About sending telemetry to LiveNX and other platforms

LiveWire is designed to send LiveFlow telemetry data to LiveAction's LiveNX and various other platforms. LiveNX is a network and application performance monitoring platform with patented end-to-end visualization for a global view of the network and the ability to drill-down to individual devices. In addition to sending LiveFlow telemetry to LiveNX, LiveFlow telemetry can also be sent other platforms including Cisco SNA and Splunk. This chapter describes the tasks you must perform in order to properly send LiveFlow telemetry data from LiveWire to LiveNX and various other platforms.

Configuring LiveFlow telemetry

To send the LiveFlow telemetry data used in LiveNX and other platforms, you must use Omnipeek to first create a new LiveFlow capture and then configure the settings for that capture to send LiveFlow telemetry to the desired platforms.

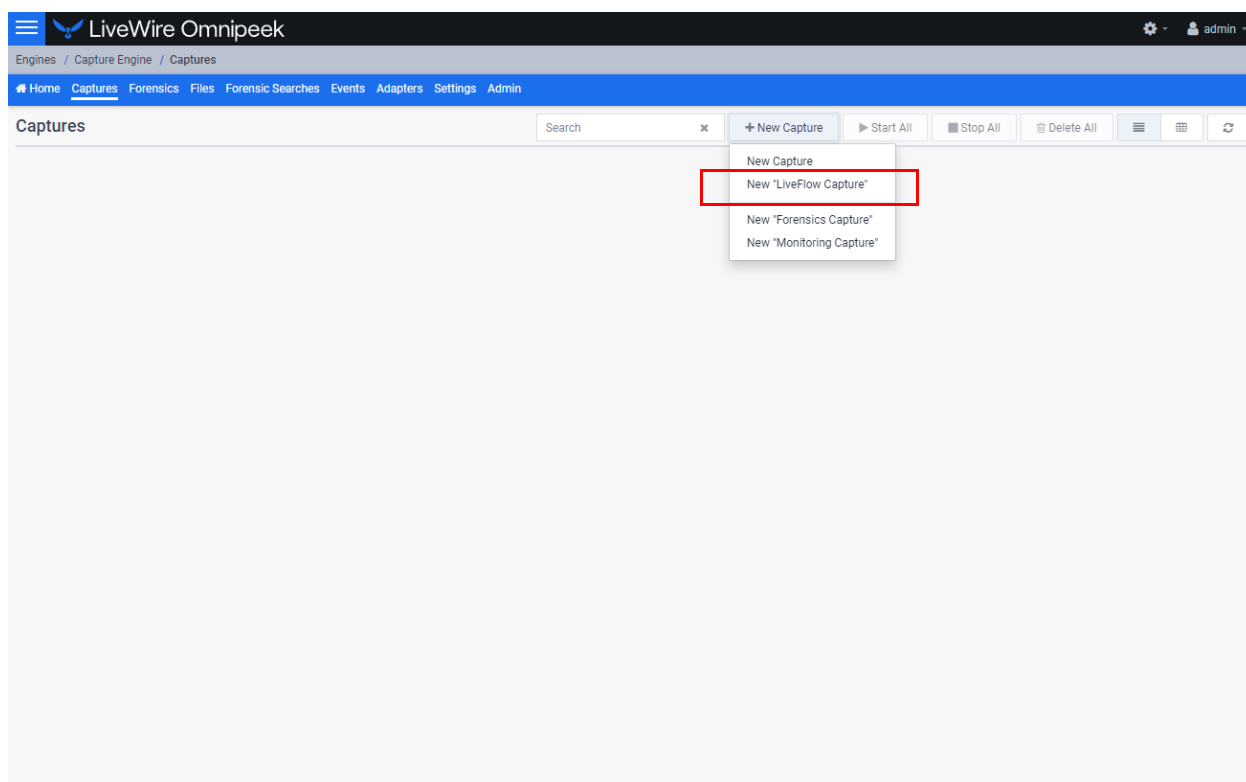

General

NAME LiveFlow Capture

Capture to disk

- Priority to CTD
- Intelligent CTD
Reduces the amount of data stored and increases retention time by slicing encrypted payloads
- Compression

FILE NAME LiveFlow-

FILE SIZE (MB) 4096

DISK SPACE FOR THIS CAPTURE 4 GB Disk Space: 132,140 GB
Files: 33,035

Retention time 1 Days

New file every 6 Hours

CAPTURE STATISTICS

- Timeline statistics
- Top statistics
- Application statistics
- VoIP statistics

PACKET FILE INDEXING

- Application
- Country
- IP Address
- IPv6 Address
- MPLS
- Physical Address
- Port
- Protocol
- VLAN

BUFFER SIZE (MB) 256

Start capture immediately

Cancel OK

Note Scroll down in the capture options to see LiveFlow settings for *IPFIX Template Refresh Interval* and *IPFIX Options Template Refresh Interval*. These settings let you configure the amount of time (in seconds) LiveWire sends template information to the desired platforms. The templates provide the instructions to the desired platforms on how to interpret the template data records in the exported LiveFlow data. The default is set to 600 seconds (10 minutes). If you make any changes to your template settings, it will take the specified number of seconds for the changes to take effect. If you recently connected LiveWire to the network, it may take up to 600 seconds for the desired platforms to see the LiveFlow data from LiveWire. You may want to adjust the settings to the desired intervals.

General

The *General* settings let you set up and configure the LiveFlow capture.

General

NAME LiveFlow Capture

Capture to disk

Priority to CTD

Intelligent CTD
Reduces the amount of data stored and increases retention time by slicing encrypted payloads

Compression

FILE NAME LiveFlow-

FILE SIZE (MB) 4096

DISK SPACE FOR THIS CAPTURE 4 GB Disk Space: 132,140 GB
Files: 33,035

Retention time 1 Days

New file every 6 Hours

CAPTURE STATISTICS

Timeline statistics

Top statistics

Application statistics

VoIP statistics

PACKET FILE INDEXING

Application Physical Address

Country Port

IP Address Protocol

IPv6 Address VLAN

MPLS

BUFFER SIZE (MB) 256

Start capture immediately

Cancel OK

- **Name:** Type a descriptive name for the capture. Unique names can help you to identify and organize your captures. Users cannot change the name of the LiveFlow capture.
- **Capture to disk:** Select this option to save packet files on your disk. Packet files saved to your hard disk (and the individual packets/packet decodes in each of the files) can be opened and analyzed at a later time with Omnipeek. If you are more interested in speeding up analysis of the data and conserving hard disk space, you may want to disable *Capture to disk*.
 - **Priority to CTD:** Select this option so that real-time analysis doesn't impact the capture-to-disk (CTD) performance. When this option is enabled, it is less likely that packets are dropped when they are captured to disk. If capturing all the packets to disk is desirable, enable *Priority to CTD*. If analysis is more important, disable *Priority to CTD*.
 - **Intelligent CTD:** Select this option to reduce the amount of data stored to disk and increase your retention time by intelligently slicing off encrypted payloads. It does this by tracking flows—if a flow is encrypted, the full data for the first 20 packets is kept and the payload from the rest of the packets is sliced. It keeps the first 20 without slicing so the certificate exchange is always included.

Intelligent CTD is an advanced feature that provides significant benefits to network security and data retention. It reduces the amount of data stored on disk and increases retention time by intelligently slicing off encrypted payloads, which helps to conserve storage space and improve system performance.

The way *Intelligent CTD* works is by tracking flows on the network. When a flow is detected as encrypted, *Intelligent CTD* keeps the full data for the first 20 packets and slices the payload from

the rest of the packets. This ensures that the certificate exchange is always included in the data, which is critical for identifying encrypted traffic and providing context for analysis.

The benefits of *Intelligent CTD* are numerous. Firstly, it helps to optimize storage usage, as the system doesn't store unnecessary data. This helps to reduce the cost of storage and improve system performance by reducing the amount of data that needs to be processed.

Secondly, *Intelligent CTD* helps to improve retention time. By conserving storage space, it enables organizations to retain data for longer periods, which can be critical for compliance and regulatory requirements. This also enables organizations to perform more in-depth analysis of data, which can provide valuable insights into network activity and help to identify potential threats.

Thirdly, *Intelligent CTD* helps to maintain privacy and compliance. By keeping the certificate exchange in the data, it ensures that the system can identify encrypted traffic and provide context for analysis, without compromising the privacy of users. This helps organizations to comply with privacy regulations and maintain the trust of their users.

Overall, *Intelligent CTD* is a powerful feature that provides numerous benefits to network security and data retention. By intelligently slicing off encrypted payloads, it helps to optimize storage usage, improve retention time, and maintain privacy and compliance.

- **Compression:** Select this option to compress blocks of packets before writing them to the file. This setting is only available when you are capturing from a capture card that supports this feature, and only when you are saving files to the *.npkt* file format.
- **File Name:** Type the name used as a base file name prefix for each capture file that is created using the *Capture to disk* option. Additionally, each capture file is appended with a timestamp indicating the date and time the file was saved. The format of the timestamp is *YYYY-MM-DD-HH.MM.SS.mmm*.
- **File Size (MB):** Enter or select the maximum file size before a new file is created.
- **Disk Space For This Capture:** Move the slider control to set the amount of hard disk space allocated for the capture. The minimum value of the slider is the minimum size of disk space a capture can occupy.
 - **Retention time:** Select this option to configure how long CTD files can remain on disk. You will need to configure the amount of minutes, hours, or days. For example, if you specify 3 days as the retention time, you'll only see the CTD files written within the past 3 days regardless of how much disk space you reserve for the capture.
 - **New file every:** Select this option to create a new CTD file at a specific time interval rather than when the CTD file size specified is reached. You will need to configure the amount of minutes, hours, or days. For example, if you specify that you want a new file every 1 minute with a 4 GB CTD file size, there will be a new CTD file every 1 minute even if the CTD file is only 1 GB in size. If the 4 GB size limit is reached before the 1 minute mark, then the *New file every* option doesn't come into effect.
- **Capture Statistics:** Select the type of statistics desired for the capture:
 - **Timeline Statistics:** Select this option to populate the capture engine database with capture data and basic network statistics such as utilization, size, distribution, etc. These statistics are then made available through the *Capture Engine Forensics* tab.
 - **Top Statistics:** Select this option to populate the capture engine database with top nodes and top protocols statistics. These statistics are then made available through the *Capture Engine Forensics* tab.
 - **Application Statistics:** Select this option to populate the capture engine database with applications statistics which are made available through the various 'application' displays.
 - **VoIP Statistics:** Select this option to populate the capture engine database with VoIP call quality and call volume statistics. These statistics are then made available through the *Capture Engine Forensics* tab.

Note Selecting the *VoIP Statistics* option may affect capture performance, especially when there are more than 2000 simultaneous calls on the network. Selecting the *Top Statistics* option may affect capture performance, especially when there are more than 10,000 active nodes captured on the network.

- *Packet File Indexing*: Under certain conditions, *Packet File Indexing* increases performance for forensic searches that use software filters. Overall capture-to-disk performance can degrade slightly, but forensic search results may be returned significantly faster if the packet elements being filtered are contained in the index and the packet characteristic is sparsely located within the packet files being searched. Enable the packet characteristics below you are most likely to use in a forensic search software filter.
 - *Application*
 - *Country*
 - *IP Address*
 - *IPv6 Address*
 - *MPLS*
 - *Physical Address*
 - *Port*
 - *Protocol*
 - *VLAN*
- *Buffer Size (MB)*: Enter a buffer size, in megabytes, for the amount of memory dedicated for the capture buffer. The capture buffer is where packets are placed for analysis. The default is 256 megabytes. A larger buffer can reduce or eliminate packet loss due to spikes in traffic. When *Capture to disk* is enabled, the *Buffer Size* option is unavailable.
- *Start Capture Immediately*: Select this option to immediately begin capturing packets once you click **OK**.

Adapter

The *Adapter* settings display the capture adapters available on LiveWire. Select the desired adapter for the LiveFlow capture.

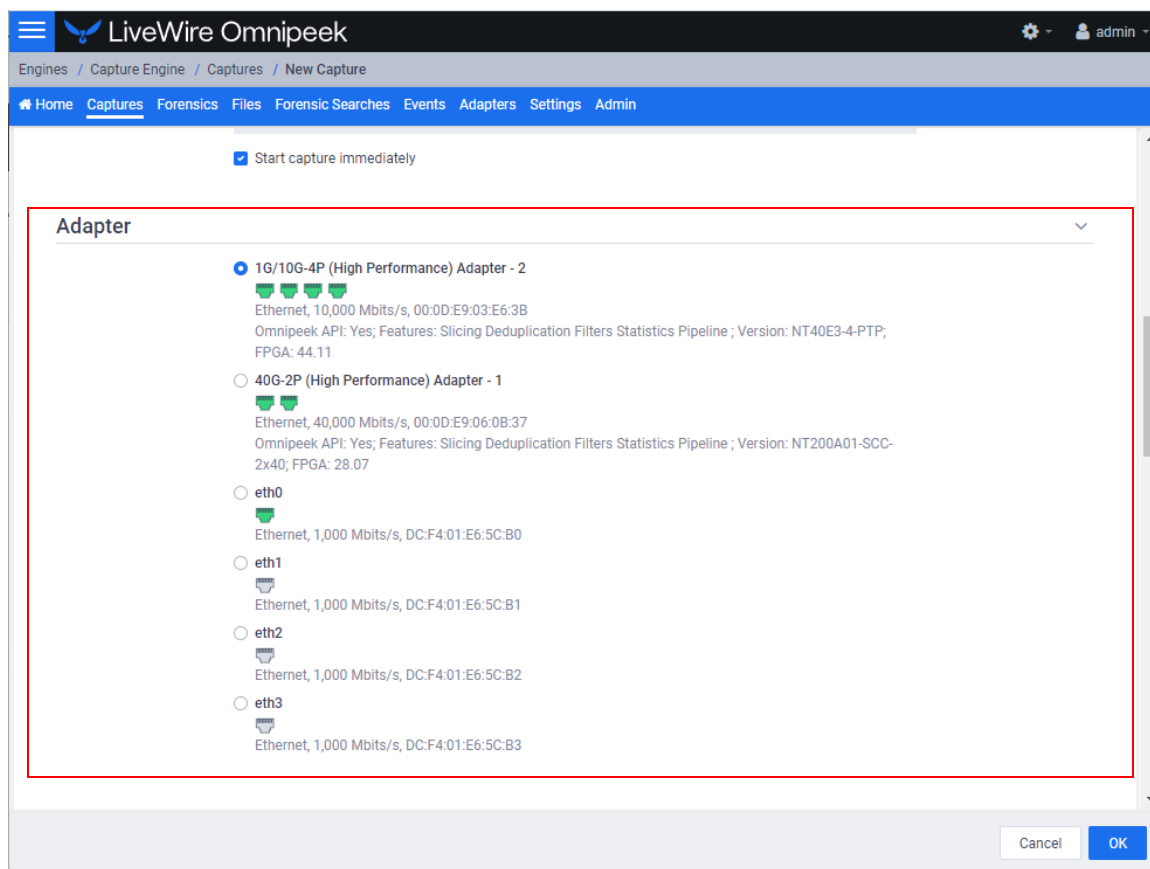

Hardware Profiles

If the selected adapter supports hardware profiles, then Hardware Profiles settings are available and can be selected and configured for the LiveFlow telemetry.

Hardware profiles tell a capture adapter the type of traffic to capture and how to manage that traffic. Hardware profiles can slice the packets, discard error or duplicate packets, and apply an address, port, mpls, vlan, or value filter. Different settings can be applied per capture adapter channel as well.

Important! All of the hardware profile settings are applied in hardware, and allow for better performance than performing these operations in software.

Note Only one hardware profile per capture can be implemented at a time.

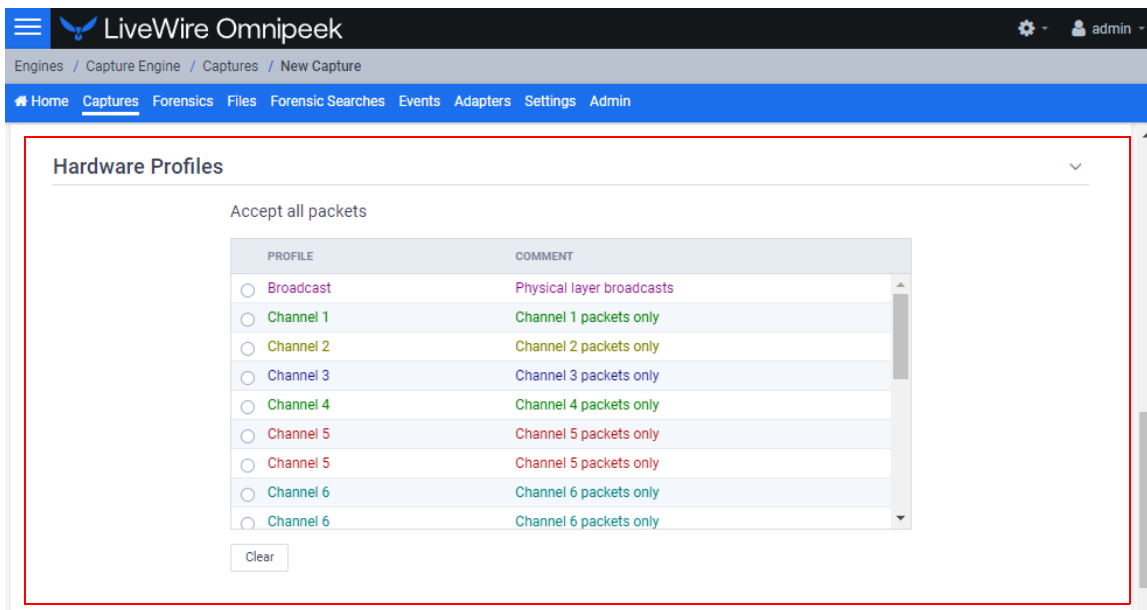

The **Hardware Profiles** view in the **Settings** view allows you to define and manage your hardware profiles.

To create a new hardware profile:

1. Display the **Hardware Profiles** view from the **Settings** view.

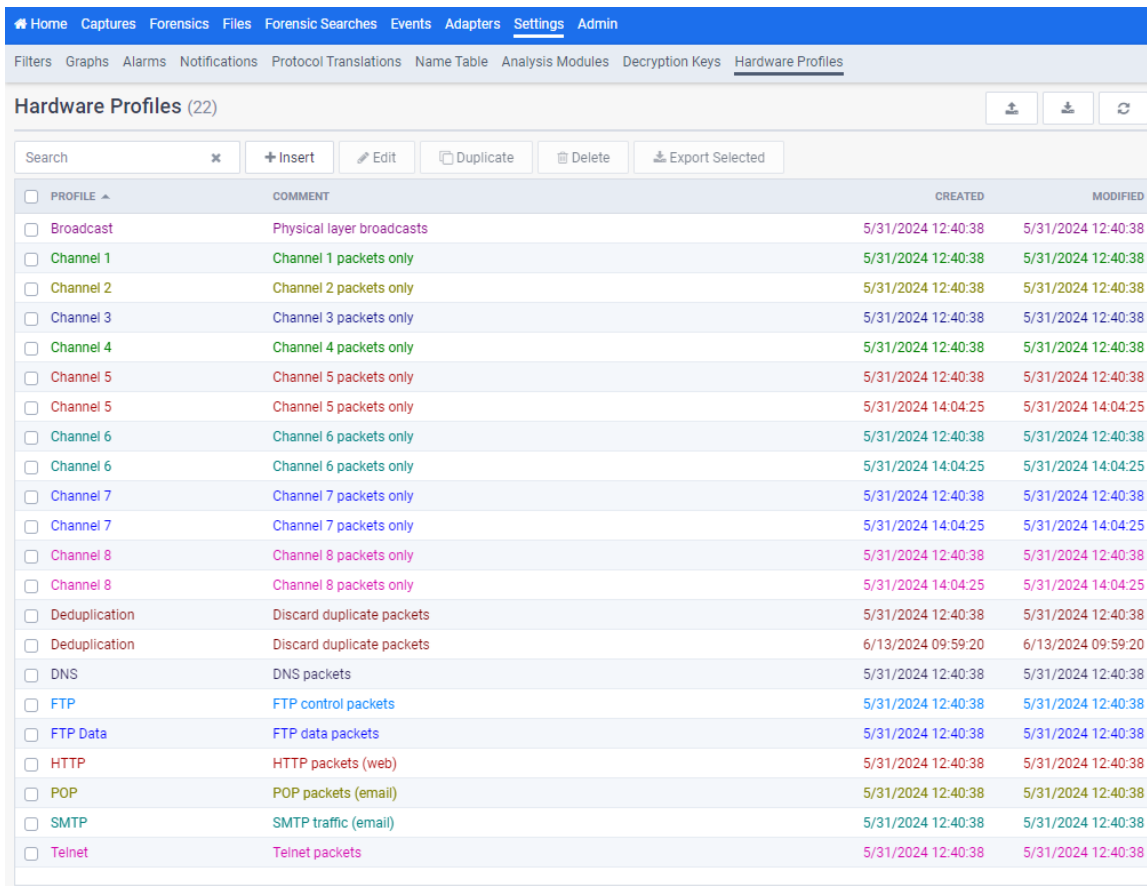

2. Click *Insert*. The **Insert Profile** view appears.

3. Configure the settings:

Important! Hardware profiles containing an overly complex configuration using the options specified below may result in an error dialog indicating that the hardware profile is too complex. When starting a capture, you may also get the error dialog when multiple captures use hardware profiles that are collectively too complex when used together. If you receive this error dialog, try reducing the complexity of the hardware profile. For example, try limiting the number of filters, reduce the number of channels, limit the number of VLAN IDs or MPLS labels, or limit the number of layers used in the hardware profile.

Additionally, when using multiple hardware profiles on the same capture adapter, these hardware profiles should be exclusive with each other (capturing a unique set of packets) or else you may find that some of the captures are missing packets since a packet can only be sent to one capture. When a packet matches more than one hardware profile in use, the most recent captures have precedence over less recent captures.

- *Profile:* Type a name for the profile.
- *Color:* Select a color for the profile.
- *Comment:* Type a comment to provide a more complete description of the hardware profile's properties.
- *Slice packets (all channels):* Select this option and specify how to slice the packets.

Important! If you have two captures on the same capture adapter, and one has a hardware profile that has *Slice packets (all channels)* enabled, while the other has *Slice packets (all channels)* disabled, only the last capture started receives packets while the other capture stops receiving packets.

- *Discard duplicate packets:* If your capture adapter supports this feature, this option is available and can be selected to discard duplicate packets.

Important! If you have two captures on the same capture adapter, and one has a hardware profile that has *Discard duplicate packets* enabled, while the other has *Discard duplicate packets* disabled, only the last capture started receives packets while the other capture stops receiving packets.

- *Apply Channel 1 settings to all channels:* Select this option to assign the same properties defined for Channel 1 to all channels. Clear the check box if you want to define properties separately for each channel.
- *Discard error packets:* Select this option to discard error packets.
- *Reject packets matching this filter:* Select this option to pass packets to Omnippeek that do not match this filter.
- *Address filter:* Select this check box to specify a filter parameter based on address.

Note Wildcard addresses (or range of addresses) and CIDR range filtering are supported for *Address filter*.

- *Type:* Select the type of addresses you want to enter. Both Address 1 and Address 2 must be of the same type and must be entered in the correct format.
Click *Direction* below to select the send/receive relationship between Address 1 and Address 2.
- *Address 1:* Type or select the first address for the filter.
- *Direction:* Select the direction for the filter.
- *Address 2:* Type or select the second address for the filter.
- *Any address:* Select this option to specify any address for Address 2.
- *Port filter:* Select this check box to specify a filter parameter based on port.
 - *Type:* Select the type of port you want to enter. Both Port 1 and Port 2 must be of the same type and must be entered in the correct format.
Click *Direction* below to select the send/receive relationship between Port 1 and Port 2.
 - *Port 1:* Type or select the first port for the filter.
 - *Direction:* Select the send/receive relationship between Port 1 and Port 2.
 - *Port 2:* Type or select the second port for the filter.
 - *Any port:* Select this option to specify any port for Port 2.
- *VLAN filter:* Select this option to enable VLAN filtering. This allows you to enter a comma separated list of VLAN IDs to match against.
 - *IDs:* Type the list of VLAN IDs, separated by a comma. The list cannot exceed 32 entries and must be within the valid VLAN ID range of 0 to 0xFFFF.
 - *Layers:* Select how deep of a VLAN stack to match against, with 1 being the minimum and 2 being the maximum.
- *MPLS filter:* Select this option to enable MPLS filtering. This allows you to enter a comma separated list of MPLS labels to match against.

- *Labels*: Type the list of MPLS labels, separated by a comma. The list cannot exceed 32 entries and must be within the valid MPLS Label range of 0 to 0xFFFFF.
- *Layers*: Select how deep of an MPLS stack to match against, with 1 being the minimum and 3 being the maximum.
- *Value filter*: Select this option to enable Value filtering. This allows to add a combination of Value filters, which are connected to each other through AND/OR conjunctions. You can add up to four Value filters due to hardware limitations on the capture adapter.
 - *And*: Select to add an 'And' to the filter.
 - *Or*: Select to add an 'Or' to the filter.
 - *Delete All*: Click to delete the parameters of the filter.
 - *Offset*: Type or select a signed number between -1024 and 1024, inclusive.
 - *Offset Relative To*: Select the offset relative to the beginning of each packet.
 - *Length*: Select the length of the filter.
 - *Mask*: Type a mask for the *Value* of the filter. This mask must represent a single continuous range of bits. This field is ignored if *Length* is an address (MAC, IPv4, or IPv6).
 - *Operator*: Select an operator for the filter.
 - *Value*: If *Length* is 1 Byte, 2 Bytes or 4 Bytes, the *Value* must be an unsigned number that does not exceed the number of bytes specified.

If *Length* is an address (MAC, IPv4 or IPv6), the *Value* must be a valid address of that type, which can include wildcards and CIDR ranges.

4. Configure other channels if you are not applying Channel 1 settings to all channels, or if you want to define properties separately for each channel.
5. Click **OK** to add the new hardware profile to the list of profiles.

LiveFlow

The *LiveFlow* settings lets you further configure the LiveFlow data of the capture.

IPFIX Max Payload

- *IPFIX Max Payload (Bytes)*: Enter the number of bytes indicating the maximum payload size (in bytes) for generated IPFIX packets. You can configure a value between 256 and 65535.

IPFIX Template Refresh Interval

- *IPFIX Template Refresh Interval (Seconds)*: Enter or select the number of seconds in which LiveWire generates and sends IPFIX template records to the desired platforms. The templates provide the instructions to the desired platforms on how to interpret the template data records in the exported LiveFlow data. The default is set to 600 seconds (10 minutes). You can configure anywhere from 1 to 1800 seconds. If you make any changes to your template settings, it will take the specified number of seconds for the changes to take place.

Note If you recently connected LiveWire to the network, it may take up to 600 seconds for the desired platforms to see the LiveFlow data from LiveWire. You may want to adjust this setting to the desired intervals.

IPFIX Options Template Refresh Interval

- *IPFIX Options Template Refresh Interval (Seconds)*: Enter or select the number of seconds in which LiveWire generates and sends IPFIX option template records. The templates provide the instructions on how to interpret the template data records in the exported LiveFlow data. The default is set to 600

seconds (10 minutes). You can configure anywhere from 1 to 1800 seconds. If you make any changes to your template settings, it will take the specified number of seconds for the changes to take place.

Note If you recently connected LiveWire to the network, it may take up to 600 seconds the desired platforms to see the LiveFlow data from LiveWire. You may want to adjust this setting to the desired intervals.

Flow Refresh Interval

- *Flow Refresh Interval (Seconds)*: Enter or select the number of seconds in which LiveWire generates and sends IPFIX data records. The default is set to 600 seconds (10 minutes). You can configure anywhere from 1 to 1800 seconds. If you make any changes to your template settings, it will take the specified number of seconds for the changes to take place.

Analysis

- *Application Delay (AD), Client Network Delay (CND), Network Delay (ND), and Server Network Delay (SND)*: Select this option to perform latency and delay analysis in the LiveFlow telemetry.
- *Enforce 3-Way Handshake*: Select this option to require a 3-way handshake (SYN, SYN-ACK, ACK) for a TCP flow in order for it to be included in processing and analyzing the LiveFlow telemetry. The *Enforce 3-Way Handshake* option becomes disabled and cannot be selected whenever 'Platform' records are enabled.
- *TCP Expert Events - Connection Lost, Connection Refused, Low Window, and Zero Window*: Select this option to perform TCP quality analysis (Expert) in the LiveFlow telemetry.
- *TCP Retransmissions*: Select this option to perform TCP retransmission analysis (Expert) in the LiveFlow telemetry.
- *VLAN/VXLAN/MPLS*: Select this option to perform VLAN, VXLAN, and MPLS analysis in the LiveFlow telemetry.
- *Web Analytics*: Select this option to perform web analytics in the LiveFlow telemetry.

Note The *Web Analytics* option becomes disabled and cannot be selected whenever 'Platform' records are enabled.

- *Decrypt Packets*: If *Web Analytics* is enabled, the *Decrypt Packets* option is made available. Select this option to perform decryption analysis on HTTPS packets in the LiveFlow telemetry. You will need to also click *Manage* to configure the Decryption Keys that allow you to decrypt packets.

Record Specific Options

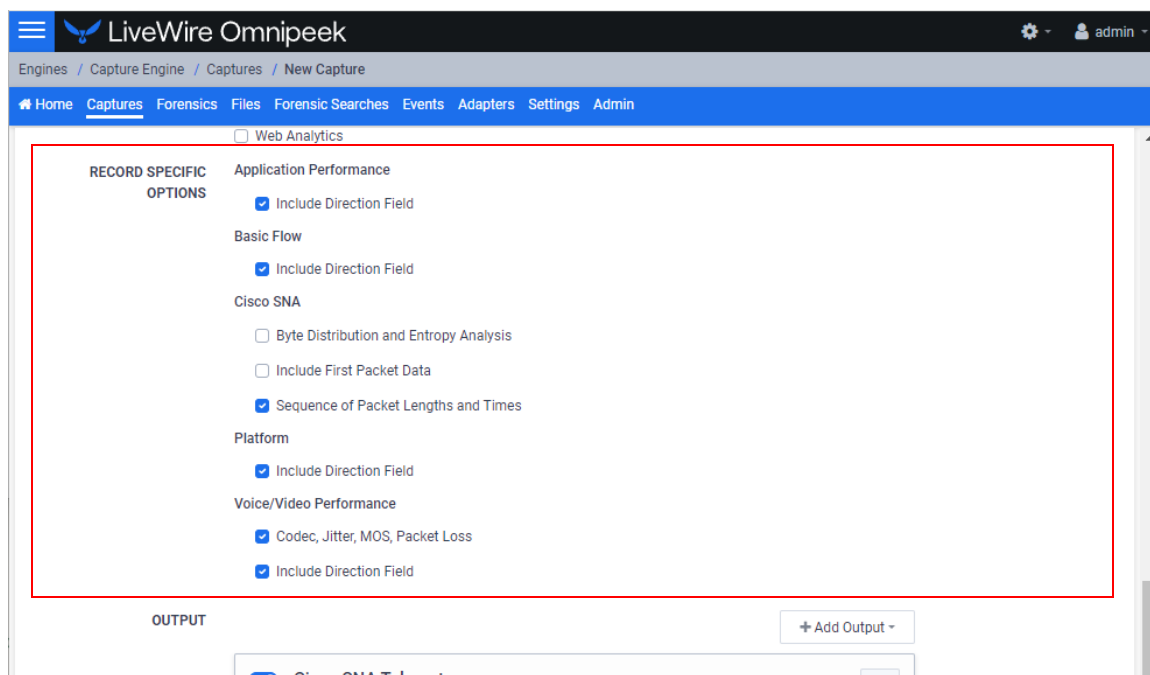

- *Application Performance*
 - *Include Direction Field*: Select this option to include flow direction (0 for ingress, 1 for egress) analysis in the Application Performance flow records.
- *Basic Flow*
 - *Include Direction Field*: Select this option to include flow direction (0 for ingress, 1 for egress) analysis in the Basic Flow records.
- *Cisco SNA*
 - *Byte Distribution and Entropy Analysis*: Select this option to perform Entropy and Byte Distribution analysis in the Cisco SNA flow records.
 - *Include First Packet Data*: Select this option to include the payload of the first packet of a flow in the Cisco SNA flow records.
 - *Sequence of Packet Lengths and Times*: Select this option to perform SPLT analysis in the Cisco SNA flow records.
- *Platform*
 - *Include Direction Field*: Select this option to include flow direction (0 for ingress, 1 for egress) analysis in the Platform flow records.
- *Voice/Video Performance*
 - *Codec, Jitter, MOS, Packet Loss*: Select this option to perform RTP analysis when MediaNet IPFIX flow records are generated.
 - *Include Direction Field*: Select this option to include flow direction (0 for ingress, 1 for egress) analysis in the Voice/Video Performance flow records.

Output

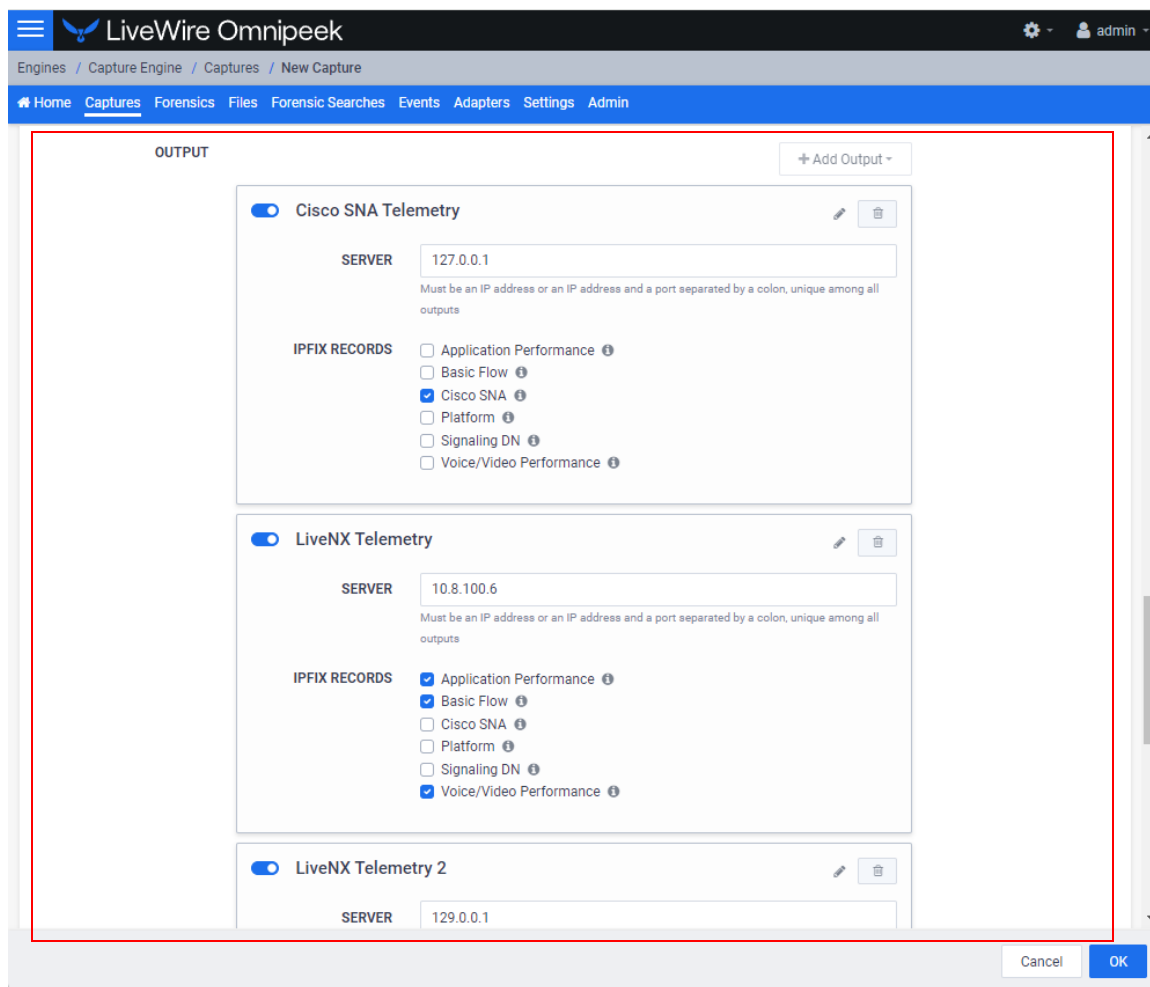

Important! The *Server* field in the *Outputs* must be unique between all targets. There can only be three output targets.

- *+Add Output*: Click to select an output target. You can select from and display the following output targets:
 - *Cisco SNA Telemetry*
 - *IPFIX Telemetry*
 - *LiveNX Telemetry*
- *Cisco SNA Telemetry*: Enable this option to send LiveFlow telemetry optimized for Cisco SNA.
 - *Server*: Enter the IP address of the server which receives the telemetry optimized for Cisco SNA.
 - *IPFIX Records*: Select the check box of the types of IPFIX records to include in the LiveFlow telemetry for Cisco SNA (click the small information icon next to the IPFIX records to view a tool tip indicating what will be in the records):
 - *Application Performance*
 - *Basic Flow*
 - *Cisco SNA* (enabled by default)
 - *Platform*

- *Signaling DN*
- *Voice/Video Performance*
- *IPFIX Telemetry*: Enable this option to send LiveFlow telemetry optimized for IPFIX.
 - *Server*: Enter the IP address of the server which receives the telemetry optimized for IPFIX.
 - *IPFIX Records*: Select the check box of the types of IPFIX records to include in the LiveFlow telemetry for IPFIX (click the small information icon next to the IPFIX records to view a tool tip indicating what will be in the records):
 - *Application Performance* (enabled by default)
 - *Basic Flow* (enabled by default)
 - *Cisco SNA* (enabled by default)
 - *Platform* (enabled by default)
 - *Signaling DN* (enabled by default)
 - *Voice/Video Performance* (enabled by default)
- *LiveNX Telemetry*: Enable this option to send LiveFlow telemetry optimized for LiveNX.
 - *Server*: Enter the IP address of the server which receives the telemetry optimized for LiveNX.
 - *IPFIX Records*: Select the check box of the types of IPFIX records to include in the LiveFlow telemetry for LiveNX (click the small information icon next to the IPFIX records to view a tool tip indicating what will be in the records):
 - *Application Performance* (enabled by default)
 - *Basic Flow* (enabled by default)
 - *Cisco SNA*
 - *Platform*
 - *Signaling DN*
 - *Voice/Video Performance* (enabled by default)

Router Mappings

- *Router Mappings*: Router mappings are used exclusively when you are exporting LiveFlow data to LiveNX, and are used by LiveNX to display aggregated traffic from different segments as separate interfaces per the router map entries you enter in the *Router Mappings* settings.

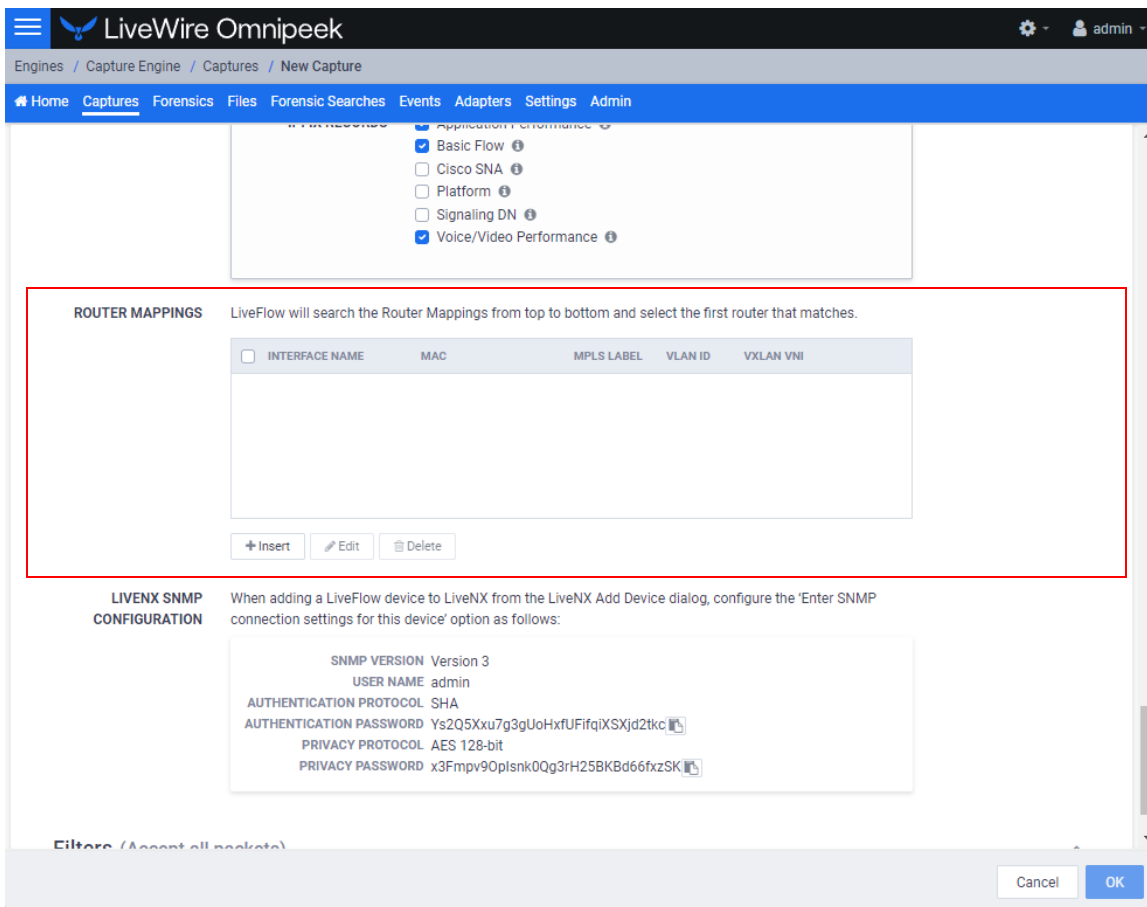

To add a router map entry for any adapter other than the Bridge adapter on LiveWire Edge, you will need to specify an interface name (ifname) and a MAC address of the gateway or router. The interface name can be up to 15 characters, and can include letters, numbers, and underscores. This will tell LiveNX to display aggregated traffic from different segments as separate interfaces per the router map entries.

To find the MAC address of the gateway or router, the CLI can be used; otherwise, capture some traffic, or do a Forensics search and look at the *Nodes* view in hierarchical mode. The top level addresses should be the MAC addresses of the gateways and routers for each segment being captured.

Note Although the CLI may display the MAC address using the abbreviated dot notation, the address must be formatted in full colon notation in the LiveWire *Router Mapping* entry dialog.

- **Interface Name:** Displays the interface name of the router. All interface names must be unique, must not be empty, must not be more than 15 characters long, and may only include the following characters: numbers, letters and an underscore (_).
- **MAC:** Displays the MAC address of the router. All MAC addresses must be a valid MAC address.
- **MPLS Label:** Displays the MPLS label (optional).
- **VLAN ID:** Displays the VLAN ID (optional).
- **VXLAN VNI:** Displays the VXLAN Network Identifier (optional).
- **Insert:** Click to add a new router mapping. You can add an unlimited number of router mappings..
- **Edit:** Click to edit the selected router mapping.
- **Delete:** Click to delete the selected router mappings from the list of router mappings.

Note The combination of *MAC address*, *MPLS Label*, *VLAN ID* and *VXLAN VNI* must be unique within the router mappings.

The router mappings are checked from top to bottom so you should be mindful to specify them in their desired order. Up and down arrows are provided for each row in the table to allow you to reorder them.

LiveNX SNMP Configuration

- *LiveNX SNMP Configuration*: For each LiveWire device that you want to use with LiveNX, you must use the Web client in LiveNX to add the device to LiveNX (see the LiveNX documentation). Since you are most likely adding LiveWire as an SNMP device to LiveNX, you will need the information provided below when adding the LiveWire device.

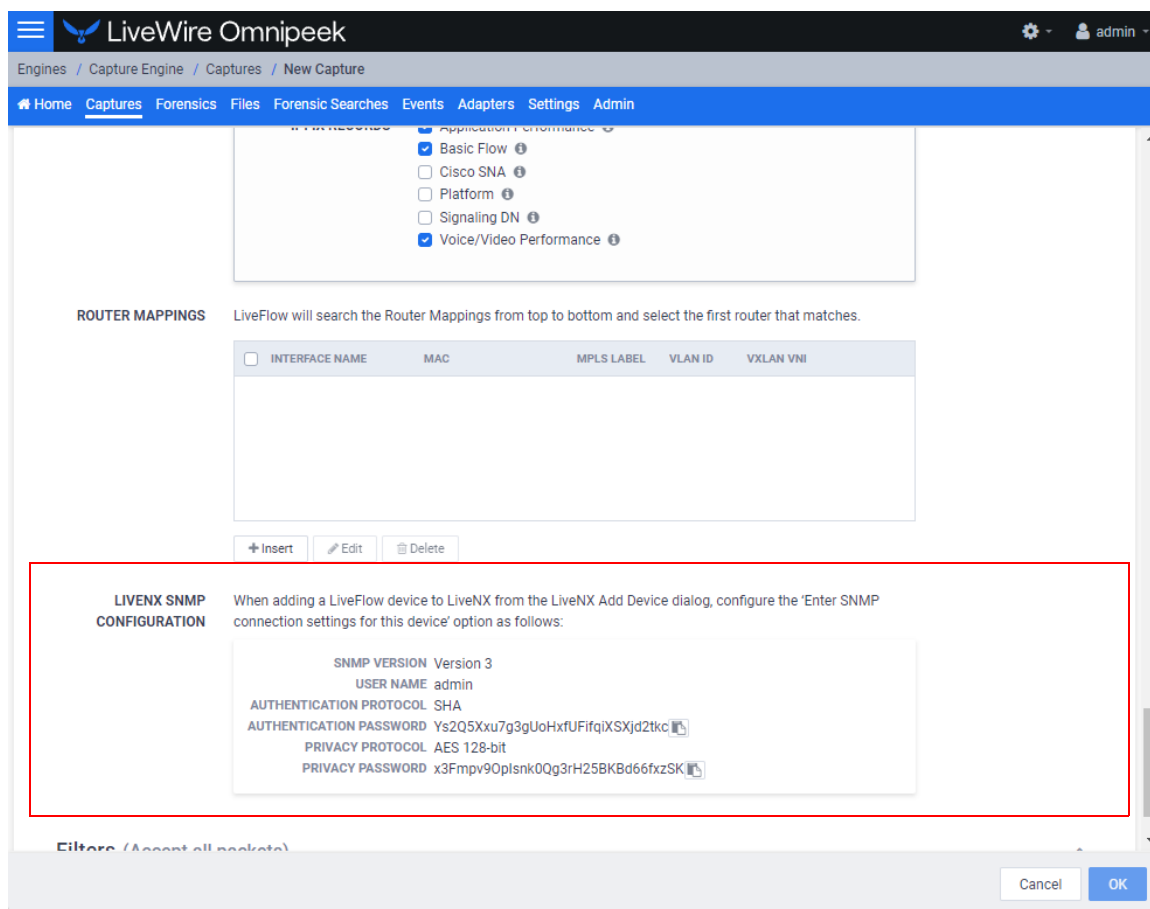

When configuring the '*Enter SNMP connection settings for this device*' option from the **Add Device** dialog in LiveNX client, configure the option as follows:

SNMP Version: **Version 3**
 User Name: **admin**
 Authentication Protocol: **SHA**
 Authentication Password: **Ys2Q5Xxu7g3gUoHxfUFifqiXSXjd2tkc**
 Privacy Protocol: **AES 128-bit**
 Privacy Password: **x3Fmpv9Oplsnk0Qg3rH25BKBd66fzxSK**

Note You can configure and change the *Authentication Password* and *Privacy Password*. See 'SNMP Credentials' in 'SNMP' on page 43.

Filters

The *Filters* settings let you enable or disable filters used when capturing packets or opening packet files. Select the filters you want to enable and then click *Accept Matching Any*, *Accept Matching All*, or *Reject Matching*.

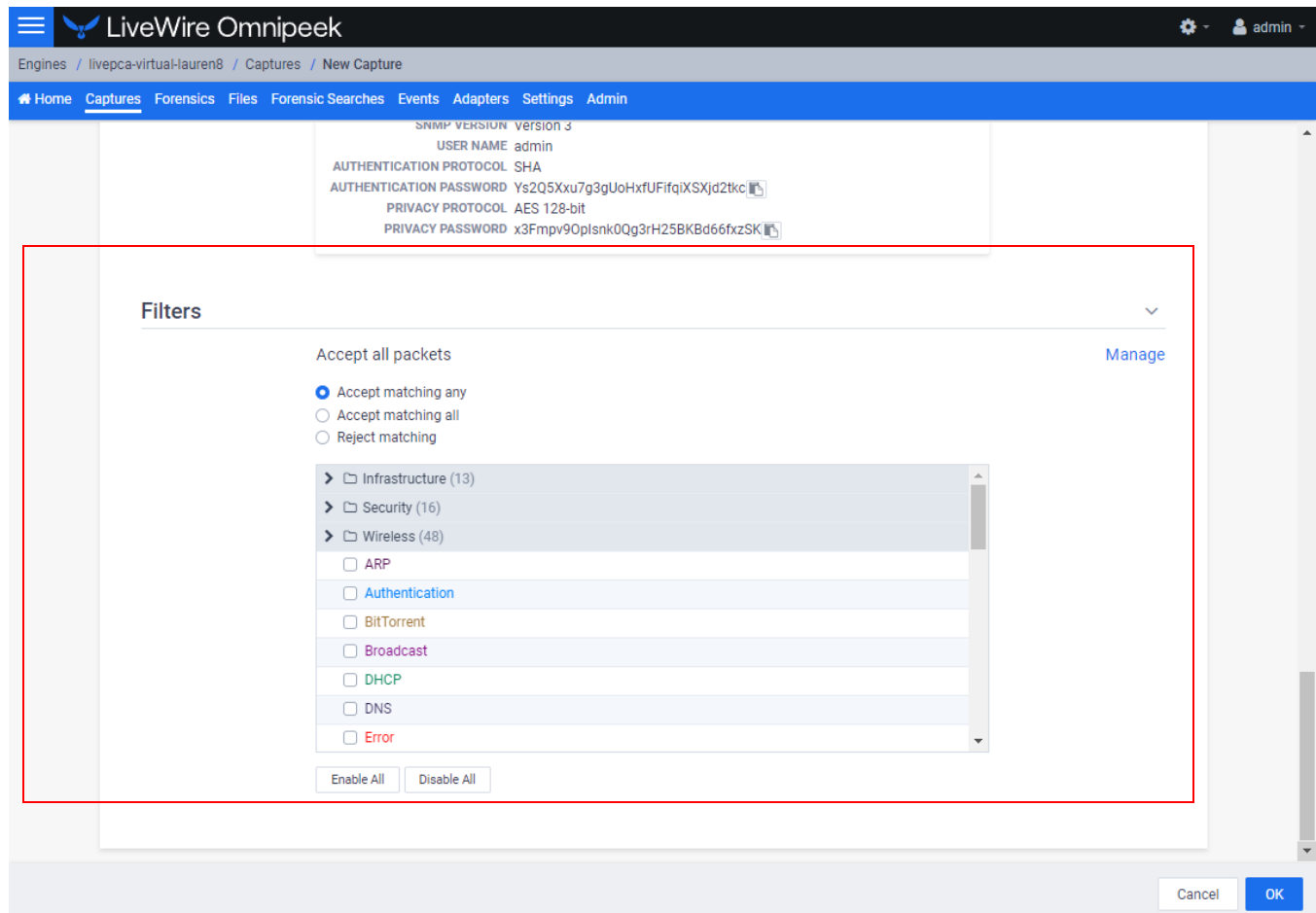

- **Accept Matching Any:** When you choose *Accept Matching Any*, only those packets which match the parameters of at least one of the enabled filters are placed into the capture buffer.
- **Accept Matching All:** When you choose *Accept Matching All*, only those packets which match the parameters of all the enabled filters are placed into the capture buffer.
- **Reject Matching:** When you choose *Reject Matching*, only those packets which do not match any of the enabled filters are placed into the capture buffer.
- **Enable All:** Click to enable all filters.
- **Disable All:** Click to disable all filters.

Recommendations for better performance at higher data rates

- At high data rates the capture file can roll over multiple times every second. For higher data rates, the File Size should be increased. This will decrease how often the capture file has to be rolled over, and indirectly increase the performance.
- Forensic Searches use the same partition as the capture files, so leave some disk space available for the Forensic Search. Typically, 10-20 GB is sufficient, but the right setting will depend on the size of the forensic searches, and how many there are.

- Packet File Indexing is used to potentially increase Forensic Search performance when relevant filters are used. However, packet file indexing also decreases capture performance and can take a considerable amount of disk space.
- The file size and file indexes are related in that the smaller the file size the more packet indexes there will be. When there are more addresses, this can lead to large index files. A larger file size will generate fewer indexes.

An example of using LiveWire, LiveNX, and OmnipEEK

A web-based version of LiveAction's OmnipEEK Network Analysis Software is available from LiveNX. You can easily start and use OmnipEEK whenever you identify an interesting alert or flow in LiveNX that needs further investigation and you want to analyze the packet level details more closely in OmnipEEK.

Note OmnipEEK can be used independently of LiveNX, directly from the LiveWire appliance by entering the IP address of the LiveWire appliance into a web browser.

For example, a user on your network experiences poor call quality during a portion of their teleconference meeting. Since you have LiveNX and are populating it with both NetFlow from infrastructure routers as well as LiveFlow from LiveWire appliance, you can visualize any flow, including this teleconference call, from end to end.

Since the user did not want to disrupt their meeting to report the issue, you find out after the call has ended that the user experienced problems. Based on the user's information, you can quickly find the flow in LiveNX and see critical metrics regarding the call, including jitter and latency. The screen below shows alerts generated by LiveFlow sent from LiveWire.

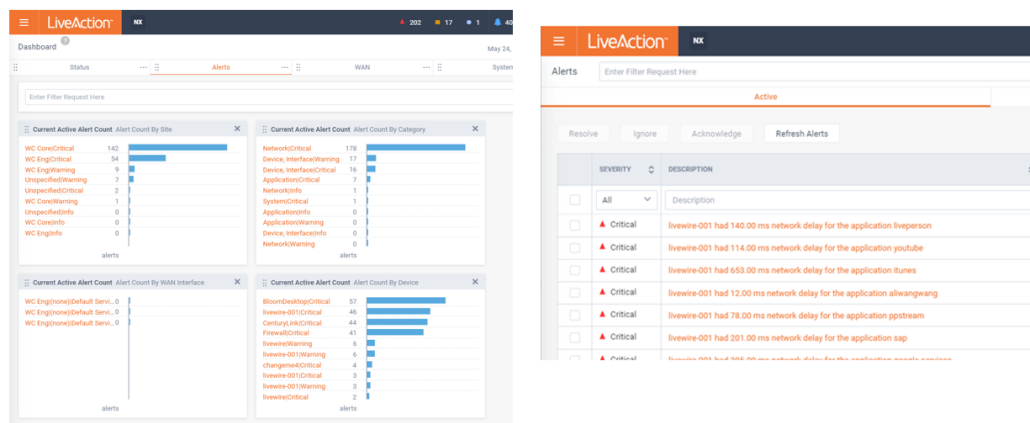

You also notice that an alert was triggered for excessive delay. This alert confirms the user's report, but you'd like to dig in even deeper to perform a root cause analysis of the issue. The best way to do this is with the network packets themselves, and since this call was captured by a LiveWire appliance you can simply click the 'Peek' button with the alert and immediately see all of the network packets for that teleconference session.

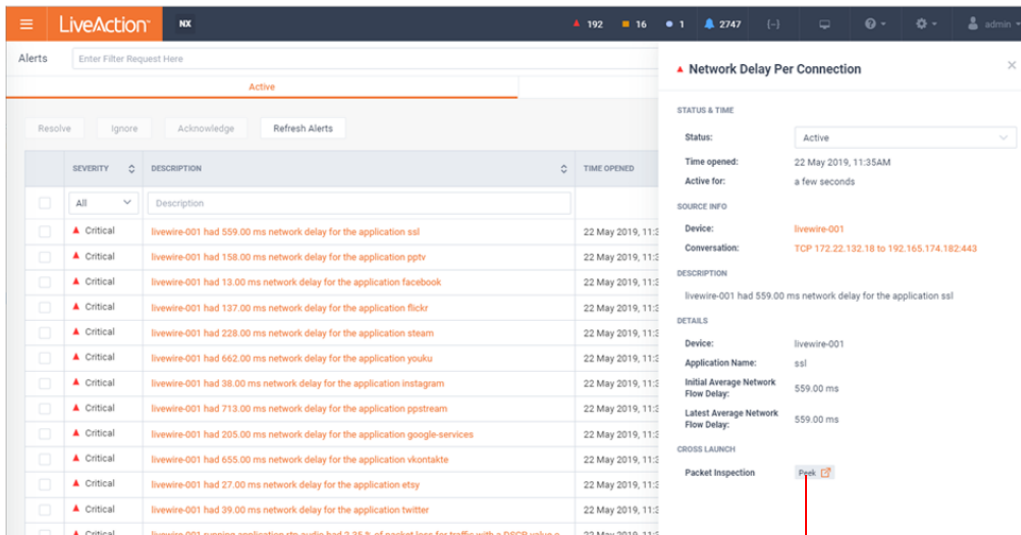

'Peek' button

When the Peek button is clicked to cross-launch to packets, a new tab will open in the browser, and a Forensic Search dialog will appear with various options. This allows you to perform detailed analysis on the call in OmnipEEK and determine exactly when the jitter was bad, and correlate that with other activity on the network, to determine the root cause.

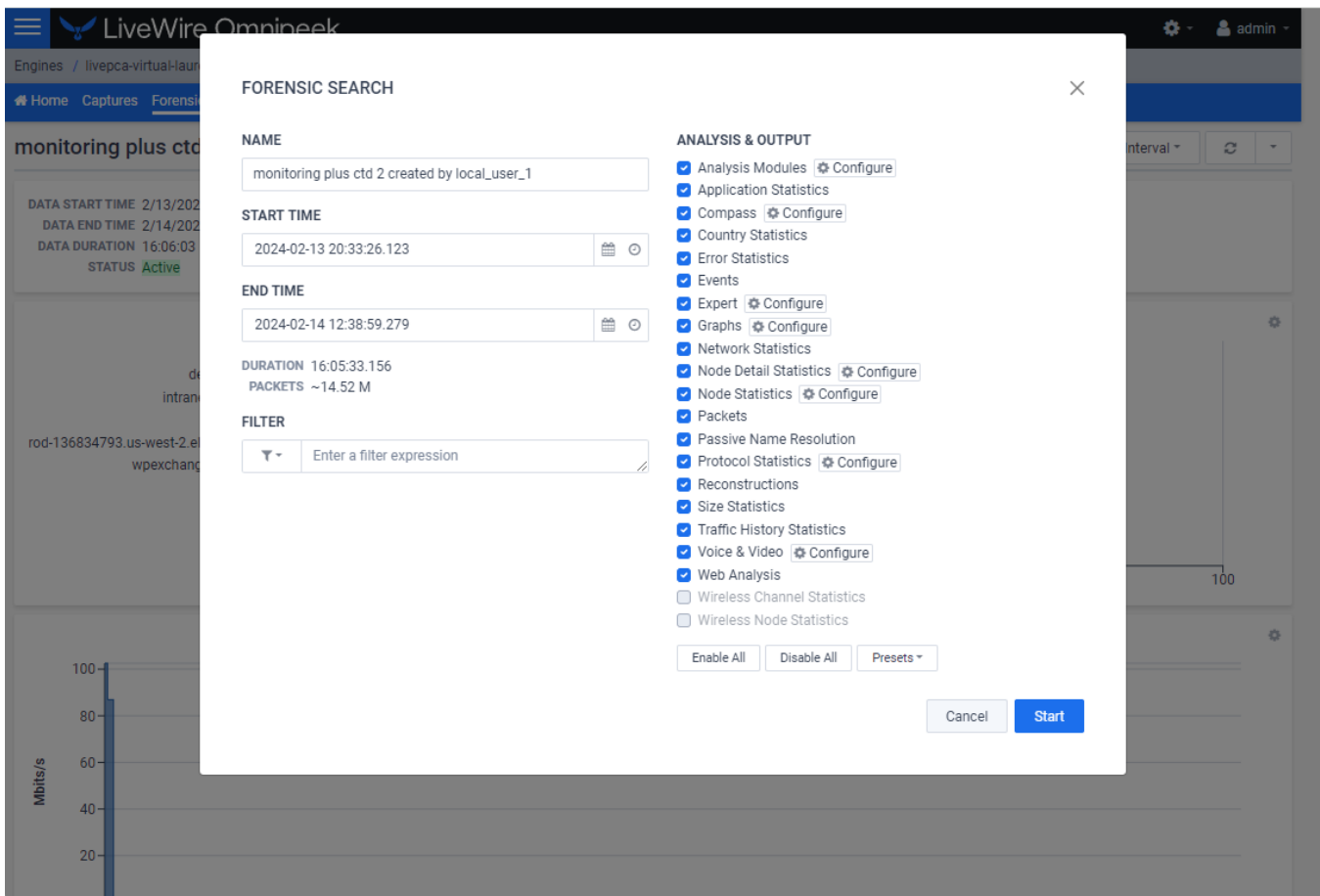

The default filter in the Forensic Search dialog includes the source and destination IP addresses of the flow. The filter can be changed to include more packets in the result, providing insight into what other traffic may be related or affecting the quality of the flow in question.

The time range can be adjusted to include more (or less) packets. This can work in conjunction with the filter, which when widened, will include more packets from the other flows between the source and destination IP.

The *Analysis & Output* options are used to include more or less analysis. The less analysis, the faster the forensic search will be. For example, if all you want are the packets, to load into Omnipcap, then just enable the packets option. Multiple forensic searches can be performed at the same time, and left running for others to use collaboratively. Keep in mind that a forensic search exists on the appliance, using memory and hard disk. When you are done using a forensic search it should be deleted.

The screen below shows various analysis views in Omnipcap which are good places to start understanding the problem as well as drill-down to the packets view.

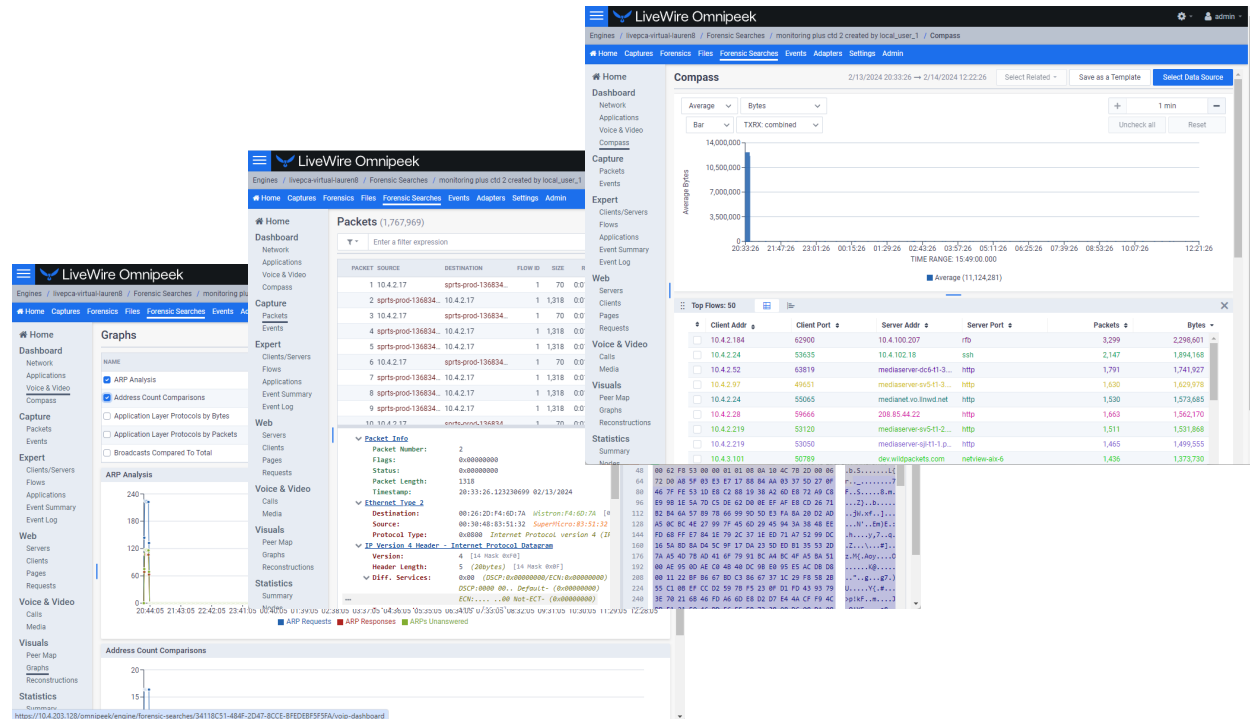

The screen below shows the *Packets* view in Omnipcap which displays the list of packets and various other details about them, including the Experts, decode, and Hex view for each one.

The screenshot displays the LiveWire Omnipeek interface. At the top, the title bar shows 'LiveWire Omnipeek' and the user 'admin'. Below the title bar, a breadcrumb trail indicates the current view: 'Engines / livepca-virtua-Lauren8 / Forensic Searches / monitoring plus ctd 2 created by local_user_1 / Packets'. A navigation menu includes 'Home', 'Captures', 'Forensics', 'Files', 'Forensic Searches', 'Events', 'Adapters', 'Settings', and 'Admin'. The left sidebar contains a 'Home' section and a 'Dashboard' section with sub-items: 'Network', 'Applications', 'Voice & Video', and 'Compass'. The main area is titled 'Packets (1,767,969)' and features a search bar with the text 'Enter a filter expression' and an 'Apply' button. Below the search bar is a table of packets with columns: 'PACKET', 'SOURCE', 'DESTINATION', 'FLOW ID', 'SIZE', 'RELATIVE TIME', 'PROTOCOL', 'APPLICATION', 'SUMMARY', and 'EXPERT'. The table lists 10 packets, all of which are HTTPS traffic from 'sprts-prod-136834...' to '10.4.2.17'. Packet 2 is selected, and its details are shown in a tree view on the left:

- Packet Info**
 - Packet Number: 2
 - Flags: 0x00000000
 - Status: 0x00000000
 - Packet Length: 1318
 - Timestamp: 20:33:26.123230699 02/13/2024
- Ethernet Type 2**
 - Destination: 00:26:2D:F4:6D:7A *Wistron:F4:6D:7A* [0]
 - Source: 00:30:48:83:51:32 *SuperMicro:83:51:32*
 - Protocol Type: 0x0800 *Internet Protocol version 4 (IP)*
- IP Version 4 Header - Internet Protocol Datagram**
 - Version: 4 [14 Mask 0xF0]
 - Header Length: 5 (20bytes) [14 Mask 0xF]
 - Diff. Services: 0x00 (DSCP:0x00000000/ECN:0x00000000)
 - DSCP:0000 00.. Default- (0x00000000)
 - ECN:.....00 Not-ECT- (0x00000000)

 On the right side of the packet details, a hex dump shows the raw data of the packet, with corresponding ASCII characters on the far right. The hex dump starts with '00 26 2D F4 6D 7A 00 30 48 83 51 32 08 00 45 00' and continues with more hex values and their ASCII equivalents like '05 14 25 57 40 00 33 06 E3 23 36 F5 F7 5F 0A 04'.

Creating and Managing API Tokens

In this chapter:

<i>About API Tokens</i>	120
<i>Creating an API Token</i>	120
<i>Managing API Tokens</i>	122

About API Tokens

API tokens are used for authentication when using the Capture Engine REST-API. You can create and manage API tokens from Omnippeek. Once a token is created in Omnippeek, you can use the token in the REST-API calls.

The instructions to create and manage API tokens for the REST-API are provided below. For instructions on how to use the Capture Engine REST-API, refer to the *API Documentation* available from the *admin/user* menu in Omnippeek.

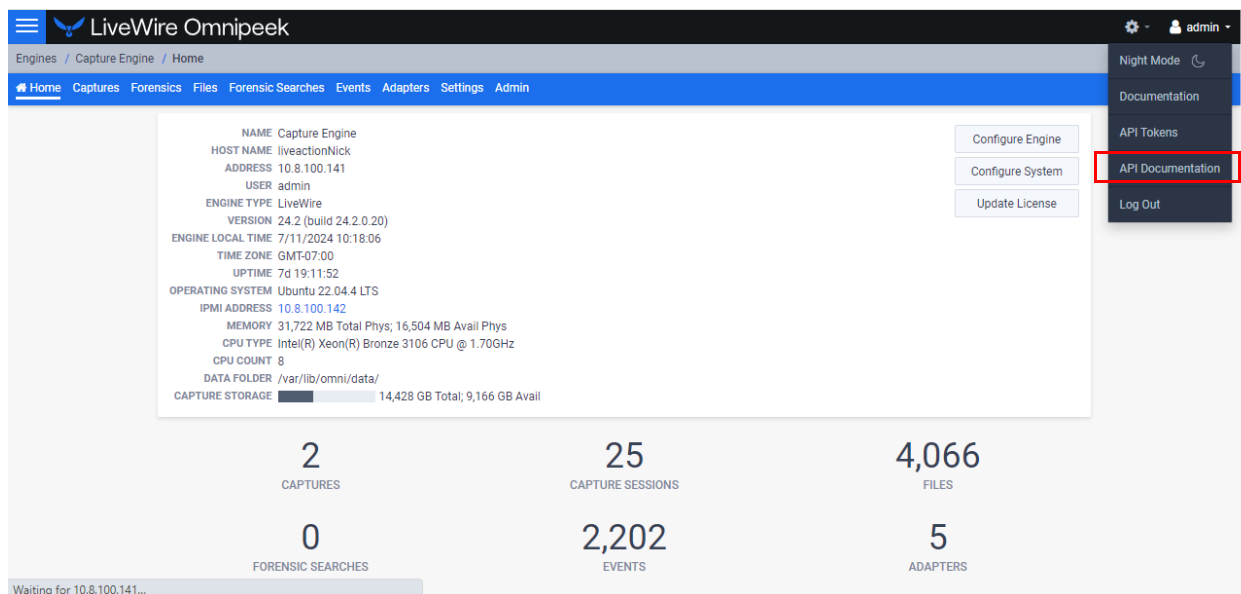

Creating an API Token

Note An API token has all of the permissions/policies as the user that created the API token.

To create an API token:

1. In Omnippeek, click **API Tokens** from the *admin* menu. The *API Tokens* page appears.

Note The **API Tokens** menu item is only available if ACL is disabled or if the *Configuration: Configure API Tokens* ACL policy is enabled. See 'Enabling Access Control' on page 125.

The screenshot shows the LiveWire Omnipeek dashboard. The top navigation bar includes 'Engines / Capture Engine / Home' and a user profile 'admin'. A dropdown menu is open, showing options: 'Night Mode', 'Documentation', 'API Tokens' (highlighted with a red box), 'API Documentation', and 'Log Out'. The main content area displays system information for the 'Capture Engine', including host name, address, user, version, and storage details. Below this, there are six summary cards: CAPTURES (2), CAPTURE SESSIONS (25), FILES (4,066), FORENSIC SEARCHES (0), EVENTS (2,202), and ADAPTERS (5). A status bar at the bottom indicates 'Waiting for 10.8.100.141...'.

The screenshot shows the 'Configure API Tokens' page. The title is 'API Tokens (11)'. There is a search bar and three buttons: '+ Insert' (highlighted with a red box), 'Edit', and 'Delete'. Below is a table with the following columns: LABEL, API TOKEN IN USE, USER, EXPIRATION TIME, and LAST ACTIVITY TIME.

LABEL	API TOKEN IN USE	USER	EXPIRATION TIME	LAST ACTIVITY TIME
<input type="checkbox"/> ad_test	Yes	LivePCAUser1	3/07/2025 14:06:21	3/07/2024 14:38:43
<input type="checkbox"/> admin	Yes	admin	2/09/2025 11:39:03	5/17/2024 09:29:45
<input type="checkbox"/> admin_test2	Yes	admin	3/07/2025 14:04:36	5/08/2024 14:23:33
<input type="checkbox"/> doc_test	Yes	admin	6/03/2025 13:10:00	5/08/2024 14:29:16
<input type="checkbox"/> doc_test2	Yes	nperrri	6/03/2025 13:10:00	5/08/2024 14:30:37
<input type="checkbox"/> doc_test34	Yes	nperrri	6/03/2025 13:10:00	5/08/2024 14:32:51
<input type="checkbox"/> lajdajkdsd	Yes	nperrri	5/17/2025 09:14:52	5/17/2024 09:14:59
<input type="checkbox"/> new	Yes	admin	5/09/2025 12:03:54	5/09/2024 12:04:00
<input type="checkbox"/> nperrri	Yes	nperrri	2/09/2025 11:39:54	5/08/2024 14:48:01
<input type="checkbox"/> RQ Test	No	admin	7/11/2025 10:24:28	7/11/2024 10:25:26
<input type="checkbox"/> test	Yes	nperrri	5/09/2025 12:22:25	5/09/2024 12:37:48

- Click **Insert**. The *Insert API Token* dialog appears.

The screenshot shows the 'INSERT API TOKEN' dialog box. It has a title bar with a close button. The dialog contains the following fields and controls:

- LABEL**: A text input field with a red border and a red circle with a white 'i' icon on the right.
- ENABLED**: A checkbox labeled 'API token in use' which is currently unchecked.
- EXPIRATION TIME**: A date and time input field showing '2024-11-03 09:17:18.885' with a calendar icon and a refresh icon on the right.
- At the bottom, there are two buttons: 'Cancel' and 'OK'.

- Configure the dialog:

- **Label:** Enter a descriptive label for the API token. A descriptive label helps you to identify the API token.
 - **Enabled:** Select the check box to enable the API token.
 - **Expiration Time:** Click the Select date and Select time icons to set the date and time in which the API token expires and can no longer be used.
4. Click **OK**. A blue banner appears and displays the API token along with its **Label**. You can now use the new token from the blue banner for REST-API authentication.

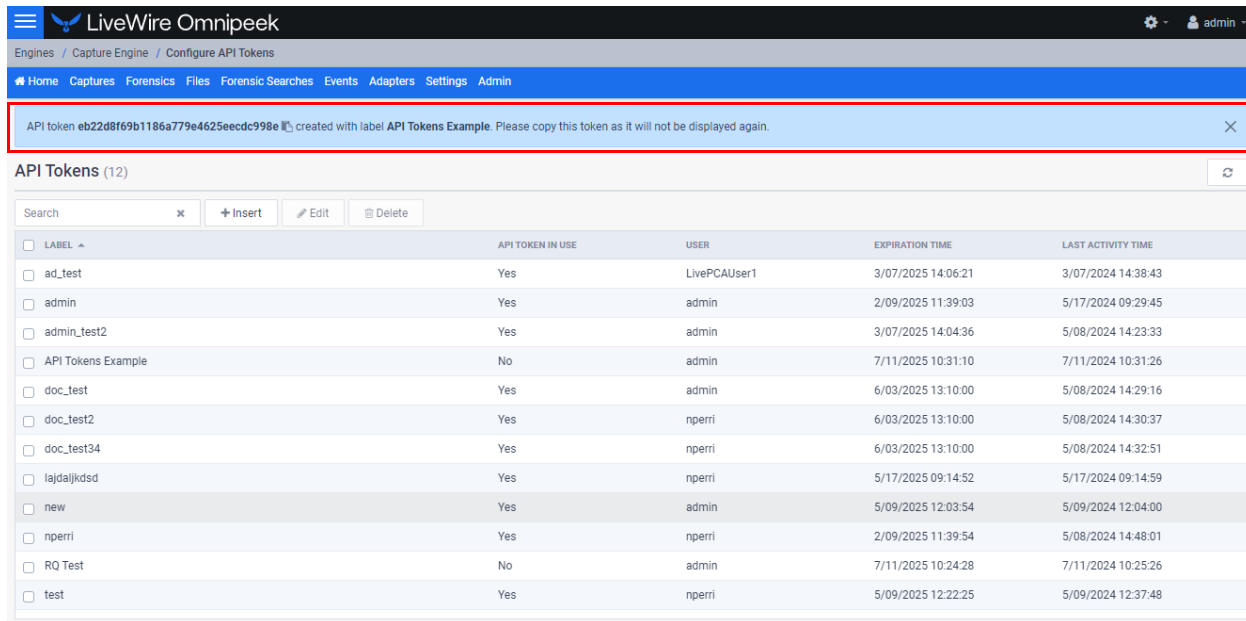

The screenshot shows the LiveWire Omnipeek interface. At the top, there is a navigation bar with the following items: Home, Captures, Forensics, Files, Forensic Searches, Events, Adapters, Settings, Admin. Below the navigation bar, a blue banner displays the message: "API token eb22d8f69b1186a779e4625eecd998e created with label API Tokens Example. Please copy this token as it will not be displayed again." Below the banner, the "API Tokens (12)" table is visible. The table has the following columns: LABEL, API TOKEN IN USE, USER, EXPIRATION TIME, and LAST ACTIVITY TIME. The table contains 12 rows of data, including the newly created token "API Tokens Example".

LABEL	API TOKEN IN USE	USER	EXPIRATION TIME	LAST ACTIVITY TIME
ad_test	Yes	LivePCAUser1	3/07/2025 14:06:21	3/07/2024 14:38:43
admin	Yes	admin	2/09/2025 11:39:03	5/17/2024 09:29:45
admin_test2	Yes	admin	3/07/2025 14:04:36	5/08/2024 14:23:33
API Tokens Example	No	admin	7/11/2025 10:31:10	7/11/2024 10:31:26
doc_test	Yes	admin	6/03/2025 13:10:00	5/08/2024 14:29:16
doc_test2	Yes	nperry	6/03/2025 13:10:00	5/08/2024 14:30:37
doc_test34	Yes	nperry	6/03/2025 13:10:00	5/08/2024 14:32:51
lajdajkdsd	Yes	nperry	5/17/2025 09:14:52	5/17/2024 09:14:59
new	Yes	admin	5/09/2025 12:03:54	5/09/2024 12:04:00
nperry	Yes	nperry	2/09/2025 11:39:54	5/08/2024 14:48:01
RQ Test	No	admin	7/11/2025 10:24:28	7/11/2024 10:25:26
test	Yes	nperry	5/09/2025 12:22:25	5/09/2024 12:37:48

Important! Please copy the token from the blue banner and save it to a safe location. For security reasons, the token will not be displayed again.

Managing API Tokens

You can manage API tokens from the *API Tokens* page.

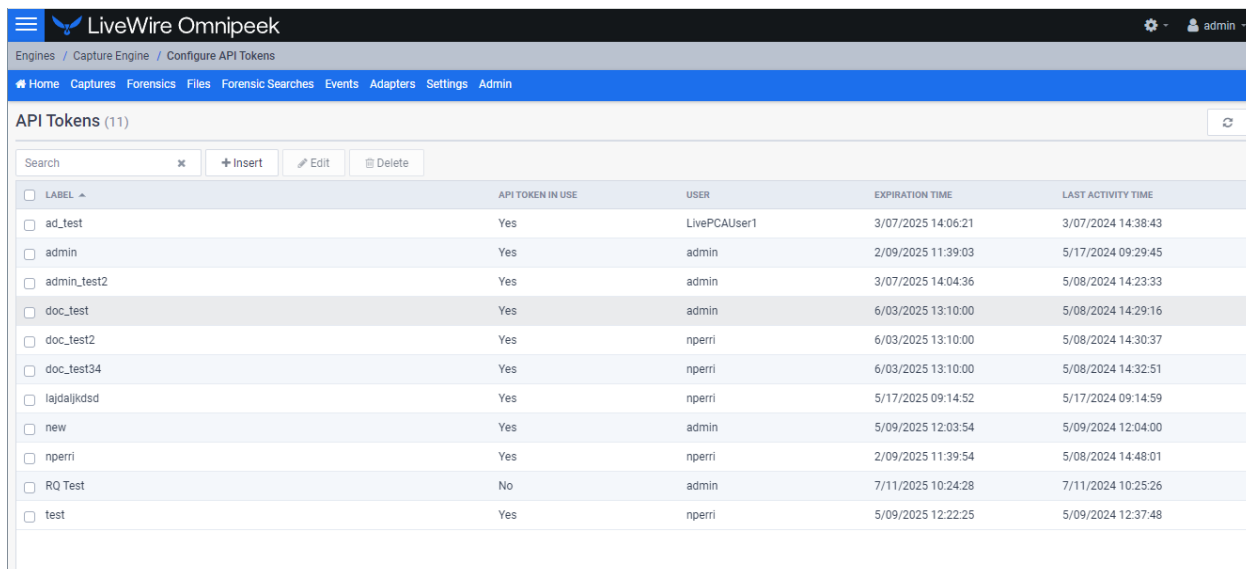

The screenshot shows the LiveWire Omnipeek interface. At the top, there is a navigation bar with the following items: Home, Captures, Forensics, Files, Forensic Searches, Events, Adapters, Settings, Admin. Below the navigation bar, the "API Tokens (11)" table is visible. The table has the following columns: LABEL, API TOKEN IN USE, USER, EXPIRATION TIME, and LAST ACTIVITY TIME. The table contains 11 rows of data, including the newly created token "API Tokens Example".

LABEL	API TOKEN IN USE	USER	EXPIRATION TIME	LAST ACTIVITY TIME
ad_test	Yes	LivePCAUser1	3/07/2025 14:06:21	3/07/2024 14:38:43
admin	Yes	admin	2/09/2025 11:39:03	5/17/2024 09:29:45
admin_test2	Yes	admin	3/07/2025 14:04:36	5/08/2024 14:23:33
doc_test	Yes	admin	6/03/2025 13:10:00	5/08/2024 14:29:16
doc_test2	Yes	nperry	6/03/2025 13:10:00	5/08/2024 14:30:37
doc_test34	Yes	nperry	6/03/2025 13:10:00	5/08/2024 14:32:51
lajdajkdsd	Yes	nperry	5/17/2025 09:14:52	5/17/2024 09:14:59
new	Yes	admin	5/09/2025 12:03:54	5/09/2024 12:04:00
nperry	Yes	nperry	2/09/2025 11:39:54	5/08/2024 14:48:01
RQ Test	No	admin	7/11/2025 10:24:28	7/11/2024 10:25:26
test	Yes	nperry	5/09/2025 12:22:25	5/09/2024 12:37:48

- *Search*: Type in the search bar to filter the table of API tokens by the 'Label' column.
- *Insert*: Click to insert a new API token. See 'Creating an API Token' on page 120.
- *Edit*: Click to edit the selected API token.
- *Delete*: Click to edit the selected API token.
- *Refresh*: Click to refresh the list of API tokens.
- *Check Box*: Select the check box of the API token you wish to manage. Selecting the check box at the top of the column selects all of the API tokens displayed in the tabel.
- *Label*: Displays the label for the API token.
- *Enabled*: Displays whether or not the API token can be used.
- *Expiration Time*: Displays the date and time in which the API token expires and can no longer be used.
- *Last Activity Time*: Displays the date and time at which the API token was last used or modified.

Important! When a new API token is successfully created, a blue banner is displayed across the top of the *API Tokens* window displaying the API token associated label for the API token. Please copy the token from the blue banner and save it to a safe location. For security reasons, the token is displayed only once and will not be displayed again.

Configuring Access Control

In this chapter:

<i>About Access Control</i>	125
<i>Enabling Access Control</i>	125
<i>About Roles</i>	129
<i>Configuring Roles</i>	129
<i>Adding a Role</i>	138
<i>Enabling Third-Party Authentication</i>	139
<i>When Upgrading From LiveWire v23.3.1 or Earlier</i>	145

About Access Control

The Access Control List (ACL) feature in LiveWire provides the ability to restrict access of predefined actions to a particular set of roles and users. This allows users to be given different privileges for when they are using LiveWire. These predefined actions are called policies. A full list of these policies are described in 'Policy Descriptions' on page 131, To learn about roles, see 'About Roles' on page 129. To manage users and groups assigned to the roles, see 'Manage Users for Roles' on page 134 and 'Manage Groups for Roles' on page 135.

Enabling Access Control

Access control is enabled via the *Engine* screen in Omnipeek.

To enable Access Control:

1. Use Omnipeek to view the *Home* page.

The screenshot shows the LiveWire Omnipeek Home page. The top navigation bar includes 'Engines / Capture Engine / Home' and a user profile 'admin'. The main content area features a 'Configure Engine' button highlighted with a red box. Below this, there are several statistics cards:

Category	Value
Captures	0
Capture Sessions	7
Files	25
Forensic Searches	0
Events	319
Adapters	5
Filters	113
Graphs	29
Alarms	60
Notifications	1
Protocol Translations	0
Names	33,864
Hardware Profiles	4
Decryption Keys	0

The engine details section includes the following information:

- NAME: Capture Engine
- HOST NAME: liveaction
- ADDRESS: 10.8.100.141
- USER: admin
- ENGINE TYPE: LiveWire
- VERSION: 23.4 (build 23.4.0.6)
- ENGINE LOCAL TIME: 11/07/2023 09:53:34
- TIME ZONE: GMT-08:00
- UPTIME: 17:05:29
- OPERATING SYSTEM: Ubuntu 22.04.3 LTS
- IPMI ADDRESS: 10.8.100.142
- MEMORY: 31,722 MB Total Phys; 26,047 MB Avail Phys
- CPU TYPE: Intel(R) Xeon(R) Bronze 3106 CPU @ 1.70GHz
- CPU COUNT: 8
- DATA FOLDER: /var/lib/omni/data/
- CAPTURE STORAGE: 14,428 GB Total; 14,304 GB Avail

2. Click **Configure Engine**. The *Configure Engine* page appears.

The screenshot shows the 'CONFIGURE ENGINE' window in LiveWire Omnipeek. The 'General' section is expanded, showing the following settings:

- NAME: Capture Engine
- IP ADDRESS: Any address (dropdown menu)
- PORT: 6367
- MAX CONNECTIONS: 100
- Enable auto discovery
- Automatically restart captures
- DATA FOLDER: /var/lib/omni/data (with a 'Browse' button)
- LOG MAX: 200000
- LOG ADJUST: 100000

At the bottom right, there are three buttons: 'Close', 'Apply to Other Engines', and 'Apply'.

3. Scroll down to the *Access Control* settings.

The screenshot shows the 'CONFIGURE ENGINE' window in LiveWire Omnipeek, scrolled down to the 'Security' and 'Access Control' sections. The 'Security' section is expanded, showing the following settings:

- Enable OS authentication only
- Enable third-party authentication
- Enable two-factor authentication
- Send audit log messages to syslog

The 'Access Control' section is also expanded, showing the following setting:

- Enable access control

A red rectangular box highlights the 'Access Control' section. At the bottom right, there are three buttons: 'Close', 'Apply to Other Engines', and 'Apply'.

4. Select *Enable access control* to expand the access control settings.

Note If *Roles* have not yet been enabled as shown below, you must manually convert access control to a roles-based approach by clicking **Convert Access Control To Roles** when the button is displayed in the *Access Control* settings. Although you can choose to not manually opt-in to the role-based approach, it is advisable to switch to a roles-based approach in order to have the ability to assign ACL policies to multiple users simultaneously rather than having to assign them to each user individually. This is incredibly useful if you have a large number of users using LiveWire.

Additionally, a roles-based approach is required to use the data exclusion feature in LiveWire, which allows you to filter packet data to only analyze and reveal a filtered subset of the packet data in a forensic search, distributed forensic search, or MSA search. This filtering is accomplished by using a specific Capture Engine filter specified in an ACL role. Therefore, the data exclusion feature is restricted to ACL roles.

Non role-based access control settings:

The screenshot shows the 'Access Control' configuration page in LiveWire Omnippeek. The page has a header with the LiveWire logo and 'admin' user information. Below the header is a navigation bar with 'Home', 'Captures', 'Forensics', 'Files', 'Forensic Searches', 'Events', 'Adapters', 'Settings', and 'Admin'. The main content area is titled 'Access Control' and contains a table of policies and users. A red box highlights a button labeled 'Convert Access Control To Roles' at the bottom of the table.

POLICY	USERS	
Allow Capture Engine usage	admin, local_user_1, local_user_2, LivePCAUser1	
Capture: Create new capture	admin, local_user_1, LivePCAUser1	
Capture: Delete captures created by other users	admin, local_user_1, LivePCAUser1	
Capture: Start/stop captures created by other users	admin	
Capture: Modify captures created by other users	admin	
Capture: View captures created by other users	admin, local_user_1, LivePCAUser1	
Capture / Forensic Search: View packets from captures and forensic searches created by other users	admin, local_user_1, LivePCAUser1	
Capture / Forensic Search: View statistics from captures and forensic searches created by other users	admin, local_user_1, LivePCAUser1	
Capture: Delete files created by other users	admin	
Configuration: Configure engine settings	admin	
Configuration: View the audit log	admin, local_user_2	
Configuration: Upload files	admin, local_user_2	
Configuration: Download packet data	admin, local_user_2	
Forensic Search: Create new forensic search	admin, local_user_1, LivePCAUser1	
Forensic Search: Delete forensic searches created by other users	admin, local_user_1, LivePCAUser1	
Forensic Search: View forensic searches created by other users	admin, local_user_1, LivePCAUser1	

Convert Access Control To Roles

[Close](#)

Role-based access control settings:

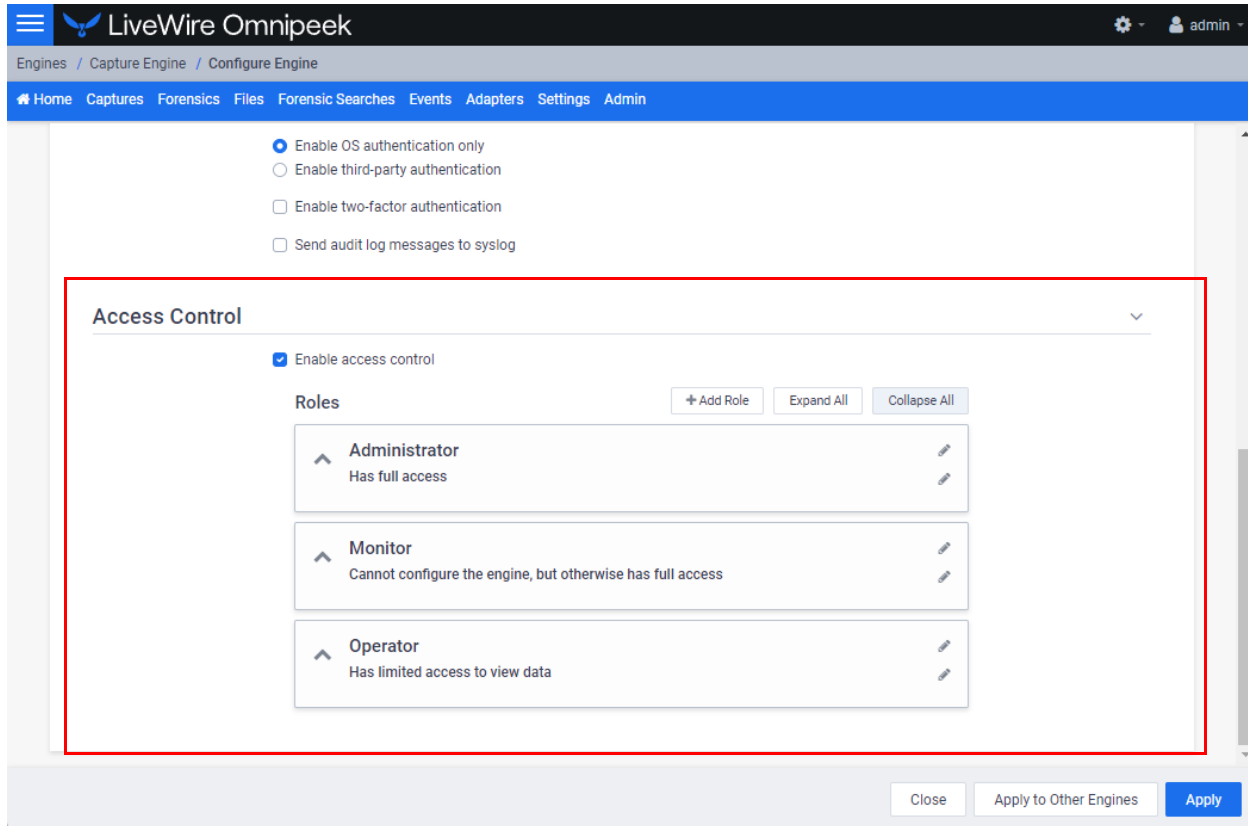

- *Enable access control*: Select this setting to enable access control.
- *Add Role*: Click to add a new role to the list of roles. You will need to provide a unique name for the role.
- *Expand All*: Click to expand the settings displayed for each of the roles.
- *Collapse All*: Click to collapse the settings displayed for each of the roles.
- *Roles*: Displays the set of *roles* for LiveWire.
 - *Administrator*: The default *Administrator* role is configured to provide full access to LiveWire to users or groups that have been assigned to this role.
 - *Monitor*: The default *Monitor* role is configured so that users or groups assigned to this role cannot configure LiveWire, but otherwise have full access to LiveWire.
 - *Operator*: The default *Operator* role is configured so that users assigned to this role have limited access to view data.

Apply to Other Engines

- *Apply to Other Engines*: Click to open a wizard that allows you to send all of the current engine configurations (security, authentication, and access control settings) to multiple other engines. All of the other engines must be running the same engine version of the current engine.

Apply

- *Apply*: Click to apply all Access Control settings to LiveWire.

About Roles

Roles are a collection of pre-defined policies for specific actions within LiveWire. For each role, one or more Policies are selected, and users or Active Directory groups are assigned. LiveWire includes a default set of roles (*Administrator*, *Monitor*, and *Operator*), with each providing a unique set of policies to the users and Active Directory groups assigned to the role. A user with the policy to configure the engine (*Configuration: Configure engine settings*) shall have the ability to adjust the policies within each of these roles and also add additional roles.

Each role has the following components:

- *Role name*: The name given to the role.
- *Role description*: A short description that describes the role.
- *Filters*: Filters can be configured to limit access to certain data in addition to global policies. See 'Configuring Filters for Roles' on page 132.
- *Users*: Users are the list of individual users of a system with a valid username/password that are assigned to a role.
- *Groups*: Groups are a list of the Active Directory groups assigned to a role. See also 'Manage Groups for Roles' on page 135.
- *Policy/Policies*: Policies are specific actions within the product that LiveAction chooses to control with permissions, for example, starting a capture. Policies are applied to users or roles only. See 'Policy Descriptions' on page 131.

Configuring Roles

Roles are configured in the *Access Control* settings in Omnipeek.

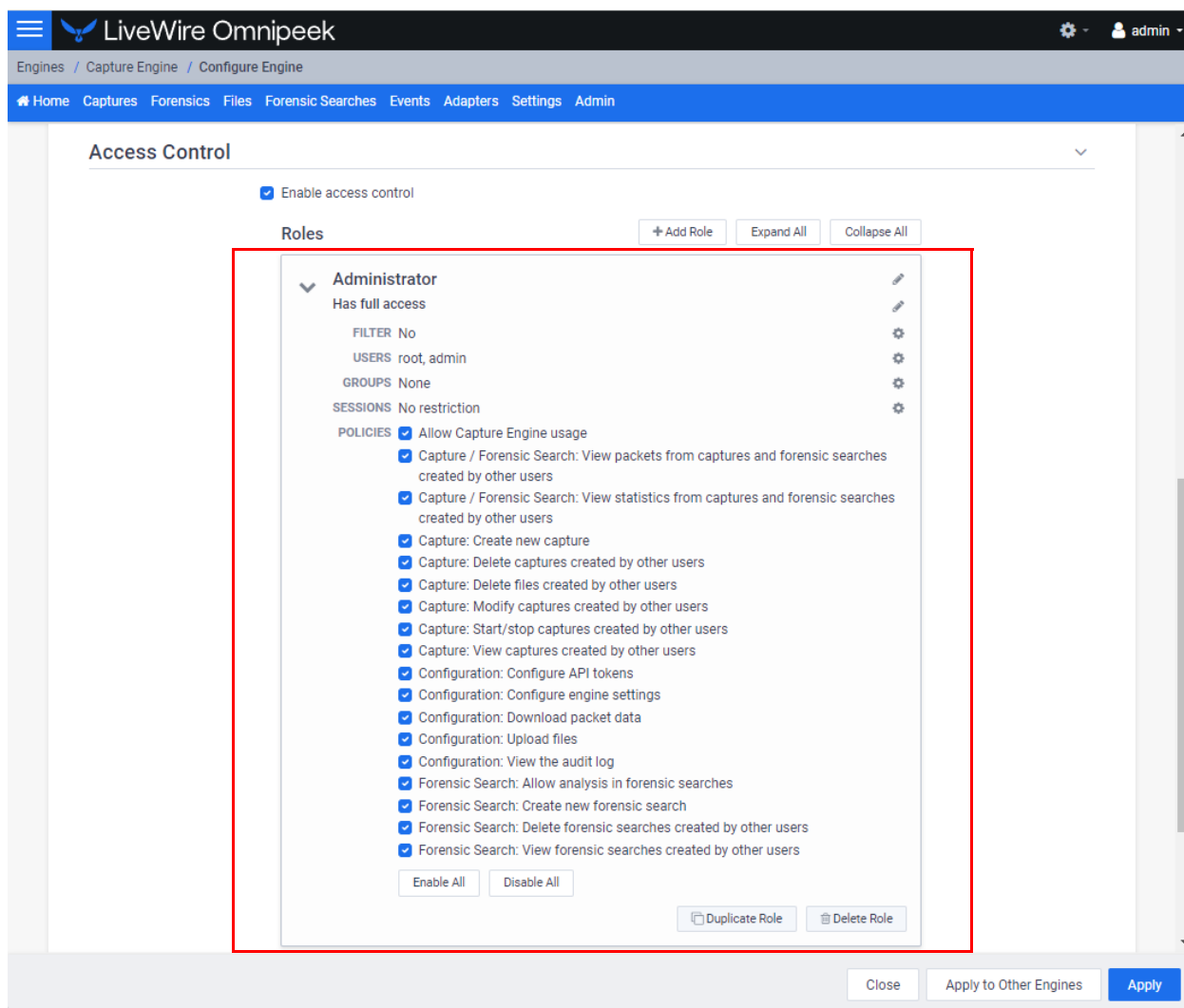

- **Role Name:** A descriptive name for the role. For example, *Administrator*, *Monitor*, and *Operator*. Click the *edit* icon to change the name. Click the up and down arrow next to the name to expand or collapse the role.
- **Role Description:** A short description of the role. For example, *Has full access*. Click the *edit* icon to change the description.
- **Filter:** Displays whether or not (*Yes* or *No*) filter rules have been configured for the role. Filters can be configured to limit access to certain data in addition to global policies. See also 'Configuring Filters for Roles' on page 132. Click the *Filter* gear icon to configure a filter.
- **Users:** Displays the users associated with the role. Click the *Users* gear icon to select one or more users. See also 'Manage Users for Roles' on page 134.
- **Groups:** Displays the Active Directory groups associated with the role. Click the *Groups* gear icon to select one or more groups. See also 'Manage Groups for Roles' on page 135.
- **Policies:** Select one or more policies associated with a role. See also 'Policy Descriptions' on page 131.
- **Enable All:** Click to enable all policies for the role.
- **Disable All:** Click to disable all policies for the role.
- **Duplicate Role:** Click to duplicate a role with the same configuration of the existing role. You will need to provide a unique name of the duplicate role.
- **Delete Role:** Click to delete the role.

Note If the same user is added to multiple roles, policy permissions will be ORed together but filters will be ANDed together.

Policy Descriptions

The following table provides a description of the policies available to enable for any role:

Policy	Description
Allow Capture Engine usage	This policy allows a user to use any REST-API or Omni protocol command, which effectively includes all Capture Engine functionality.
Capture / Forensic Search: View packets from captures and forensic searches create by other users	This policy allows a user to view packets from captures and forensic searches created by other users.
Capture / Forensic Search: View statistics from captures and forensic searches create by other users	This policy allows a user to view statistics from captures and forensic searches created by other users. This policy also allows access to MSA projects the user doesn't own.
Capture: Create new capture	This policy allows a user to create a new capture.
Capture: Delete captures created by other users	This policy allows a user to delete captures created by other users.
Capture: Delete files created by other users	This policy allows a user to delete capture files created by other users.
Capture: Modify captures create by other users	This policy allows a user to modify the capture settings for captures created by other users.
Capture: Start/stop captures created by other users	This policy allows a user to start and stop captures created by other users.
Capture: View captures created by other users	This policy allows a user to view captures and capture data created by other users. The user must also have either the View Packets ACL or View Statistics ACL permission (first two policies in this table) as well to open a capture window for a capture the user doesn't own.
Configuration: Configure API tokens	This policy allows a user to configure and view API tokens.
Configuration: Configure engine settings	This policy allows a user to configure and view engine settings.
Configuration: Download packet data	This policy allows a user to download packet files from captures and distributed forensic searches.
Configuration: Save packet data	This policy allows users to save packet data from captures and forensic searches.
Configuration: Upload files	This policy allows a user to upload or open packet files.
Configuration: View the audit log	This policy allows a user to view the Audit Log.
Forensic Search: Allow analysis in forensic searches	This policy allows the user to perform analysis in forensic searches. Without this policy, users will only be able to perform a forensic search that shows packets and only packets.
Forensic Search: Create new forensic search	This policy allows a user to create forensic searches and distributed forensic searches, and to perform a cross launch from LiveNX.
Forensic Search: Delete forensic searches created by other users	This policy allows the user to delete a forensic search, distributed forensic search, or MSA project created by others.
Forensic Search: View forensic searches created by other user	This policy allows a user to view forensic searches and distributed forensic searches created by others. The user must also have either the View Packets ACL or View Statistics ACL permission (first two policies in this table) as well to view the forensic search for a forensic search the user doesn't own.

Policy Description notes:

- In order to delete capture sessions from the Forensics view, the user must have the *Delete Captures* and the *Delete Files* policies.
- The *View Captures*, *Save Packet Data* and *Create Forensic Search* policies will affect which capture sessions are available to the user when performing a distributed forensic search or creating an MSA project. The user must have the *View Captures* policy on the target engine to see capture sessions for captures the user doesn't own. The user must have the *Save Packet Data* and *Create Forensic Search* policies on the target engine to see any of its capture sessions.
- The user must have the *Upload Files* and *Create Forensic Search* policies to create a distributed forensic search and to create an MSA project.
- Users always maintain control over their own data, for example, deleting a capture they started. See also 'Manage Users for Roles' on page 134.

Configuring Filters for Roles

Filters can be configured to limit access to certain data in addition to global policies for each role.

Note Any filters supplied when creating a forensic search will be 'ANDed' together with the role filter.

To configure filters for roles:

1. Click the *Filter* gear icon. The *Configure Filter* dialog appears.

The screenshot shows the 'Access Control' configuration page in LiveWire Omnippeek. The 'Administrator' role is expanded, showing its permissions. A red box highlights the gear icon next to the 'FILTER No' setting, indicating that the filter configuration needs to be updated.

2. Configure the filter.

The 'CONFIGURE FILTER' dialog box is shown. It has a title bar with a close button. Below the title bar, there are three buttons: 'And', 'Or', and 'Delete All'. The main area of the dialog is empty, with the text 'No filter rules added' centered. At the bottom, there are four buttons: 'Undo', 'Redo', 'Cancel', and 'OK'.

- **And:** Click to select the type of data to include in your *And* filter. You can further refine your filter by clicking the filter rule once it is added to the *Filter Rules*.
- **Or:** Click to select the type of data to include in your *Or* filter. You can further refine your filter by clicking the filter rule once it is added to the *Filter Rules*.
- **Delete All:** Click to delete all filter rules displayed in the *Filter Rules*.

Manage Users for Roles

To manage the users assigned to a role:

1. Click the *Users* gear icon. The *Add/Remove Users* dialog appears.

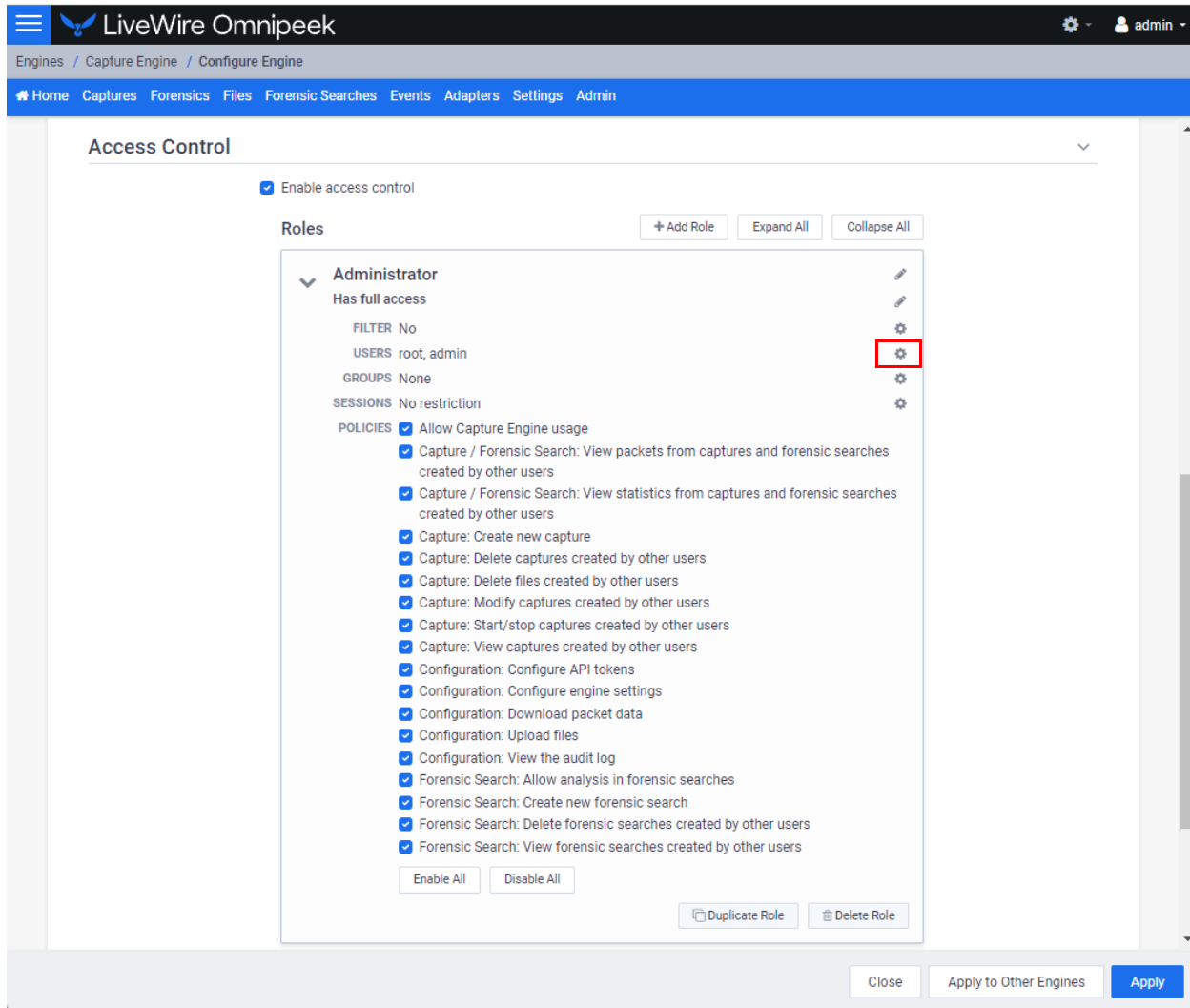

The screenshot shows the LiveWire Omnipeek interface with the 'Access Control' dialog open. The 'Administrator' role is selected and expanded, showing its permissions. A red box highlights the gear icon next to the 'USERS' field, which is currently set to 'root, admin'. The dialog includes buttons for '+ Add Role', 'Expand All', and 'Collapse All' at the top. At the bottom, there are buttons for 'Close', 'Apply to Other Engines', and 'Apply'. The 'Administrator' role has full access and includes the following permissions:

- Allow Capture Engine usage
- Capture / Forensic Search: View packets from captures and forensic searches created by other users
- Capture / Forensic Search: View statistics from captures and forensic searches created by other users
- Capture: Create new capture
- Capture: Delete captures created by other users
- Capture: Delete files created by other users
- Capture: Modify captures created by other users
- Capture: Start/stop captures created by other users
- Capture: View captures created by other users
- Configuration: Configure API tokens
- Configuration: Configure engine settings
- Configuration: Download packet data
- Configuration: Upload files
- Configuration: View the audit log
- Forensic Search: Allow analysis in forensic searches
- Forensic Search: Create new forensic search
- Forensic Search: Delete forensic searches created by other users
- Forensic Search: View forensic searches created by other users

2. Configure the users.

ADD/REMOVE USERS ×

LOCAL USERS

root	Add
root	Add
nobody	Add
nobody	Add
nperri	Add
...	Add

THIRD-PARTY AUTHENTICATION USER

<input style="width: 90%;" type="text"/>	Add
--	-----

SELECTED USERS

admin	Remove
Administrator	Remove

- *Local Users*: Displays the local users that can be added to a role. Click *Add* to add a user to the *Selected Users* list.
- *Third-Party Authentication User*: Allows users to type in third-party users from third-party authentication servers. Click *Add* to add a user to the *Selected Users* list.
- *Selected Users*: Displays the users added to the role. Click *Remove* to remove a user from the *Selected Users* list.
- *Remove All*: Click to remove all the users from the *Selected Users* list.

Manage Groups for Roles

Note If you assign a group to any of the Access Control roles, third-party authentication must also be enabled. See 'Enabling Third-Party Authentication' on page 139. Additionally, a valid Active Directory entry must be added and enabled as well.

To manage the groups assigned to a role:

1. Click the *Groups* gear icon. The *Manage Groups* dialog appears.

The screenshot shows the 'Access Control' configuration page in LiveWire Omnipeek. The 'Administrator' role is selected and expanded. The 'GROUPS' section is currently set to 'None', and a red box highlights the gear icon next to it, indicating the next step in the configuration process.

2. Configure the groups.

The 'MANAGE GROUPS' dialog box is shown. It includes a 'GROUP' input field with an 'Add' button, a 'GROUPS' list area displaying 'No groups', and a 'Remove All' button. At the bottom, there are 'Cancel' and 'OK' buttons.

- **Group:** Type in a group name to be added to a role. Click **Add** to add a group to the **Groups** list.
- **Groups:** Displays the groups added to the role. For each Active Directory group in the list, there are three buttons for the following:
 - **Validate:** Click to validate the group exists in the Active Directory server supplied in third-party authentication.

- *Users*: Click to validate a given user is found in the Active Directory group; the *Test User* dialog appears.
- *Remove*: Click to remove the group from the list.
- *Remove All*: Click to remove all groups from the *Groups* list.

Manage Sessions for Roles

Sessions are for limiting the number of concurrent login sessions for a user assigned to a specific role. For example, if there is a role called *Monitor* and its session limit is set to 2, then any user who is assigned to that role can only have a maximum of two concurrent sessions.

To manage the sessions assigned to a role:

1. Click the *Sessions* gear icon. The *Manage Sessions* dialog appears.

The screenshot shows the 'Access Control' dialog in the LiveWire Omnipeek interface. The 'Enable access control' checkbox is checked. Under the 'Roles' section, the 'Administrator' role is expanded, showing its configuration. The 'SESSIONS' field is set to 'No restriction' and is highlighted with a red box. The 'POLICIES' section contains a list of permissions, all of which are checked. At the bottom of the dialog, there are buttons for 'Enable All', 'Disable All', 'Duplicate Role', and 'Delete Role'. The main interface shows the breadcrumb 'Engines / Capture Engine / Configure Engine' and a navigation bar with 'Home', 'Captures', 'Forensics', 'Files', 'Forensic Searches', 'Events', 'Adapters', 'Settings', and 'Admin'.

2. Configure the sessions.

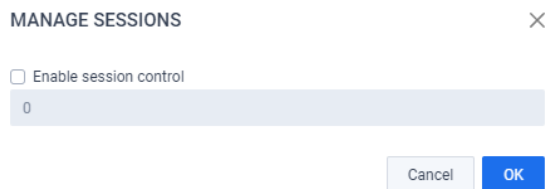

- *Enable session control*: Select this option to enable session control, and set the session limit to a number > 0.

Adding a Role

In addition to the default set of roles included with LiveWire, additional roles can be added and configured.

To add a role:

1. Click *Add Role*. The *Add Role* dialog appears.

Note You can also duplicate an existing role and its settings. You will need to provide a unique name for the role when you duplicate a role. See 'Configuring Roles' on page 129.

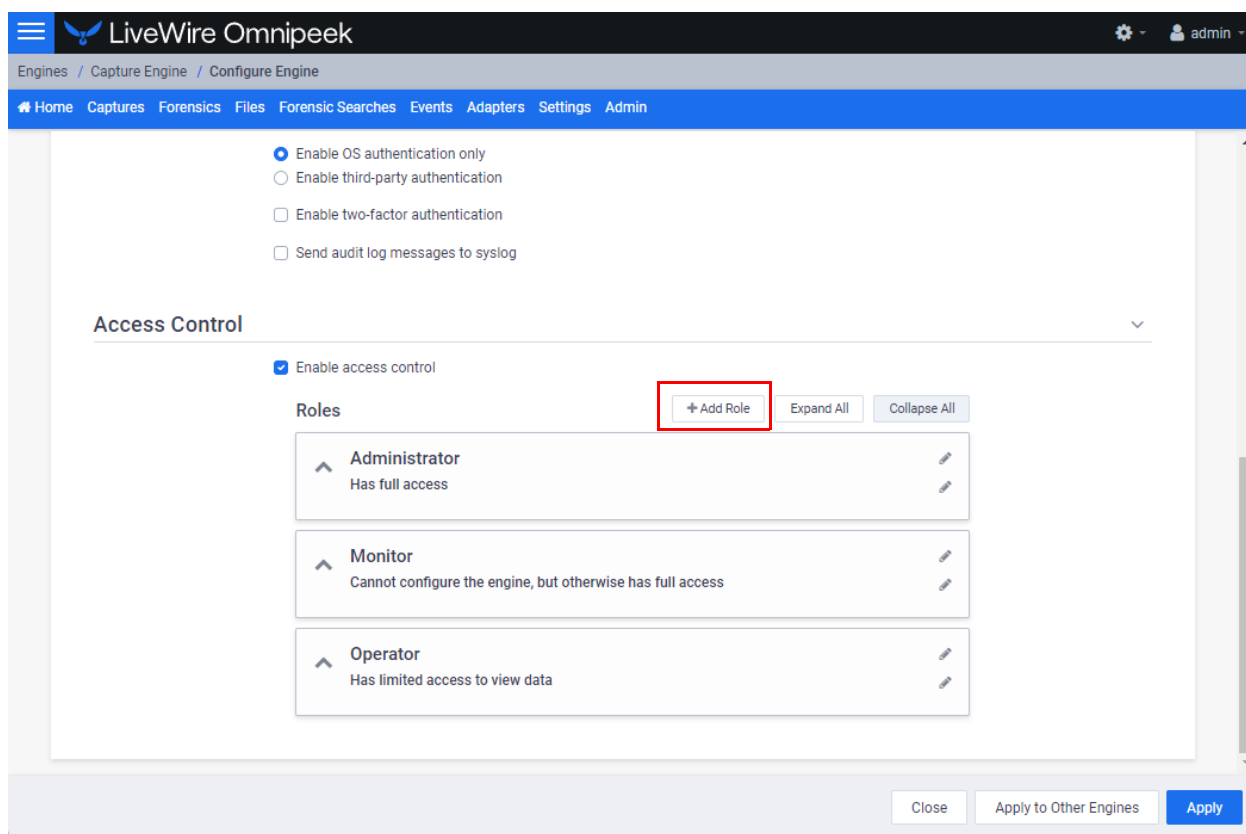

2. Configure the dialog.

ADD ROLE ×

NAME

Name must be non-empty and unique

DESCRIPTION

Cancel OK

- *Name*: Type a unique name for the role.
- *Description*: Type a description for the role.
- *OK*: Click to save the role and add it to list of roles.

Enabling Third-Party Authentication

If you assign a group to any of the Access Control roles, third-party authentication must also be enabled and include at least one Active Directory entry that is active with a non-empty *Base DN* (Domain Name), *Application Username*, and *Application Password*.

To enable third-party authentication:

1. Scroll down to the *Security* settings.

The screenshot displays the LiveWire Omnippeek configuration interface. At the top, the breadcrumb trail reads "Engines / Capture Engine / Configure Engine". The navigation menu includes "Home", "Captures", "Forensics", "Files", "Forensic Searches", "Events", "Adapters", "Settings", and "Admin".

The configuration area is divided into several sections:

- DATA FOLDER:** A text input field containing "/var/lib/omni/data" with a "Browse" button to its right.
- LOG MAX:** A text input field containing "200000".
- LOG ADJUST:** A text input field containing "100000".
- Security:** A section highlighted with a red border, containing four radio button options:
 - Enable OS authentication only
 - Enable third-party authentication
 - Enable two-factor authentication
 - Send audit log messages to syslog
- Access Control:** A section containing a checked checkbox for "Enable access control". Below this is a "Roles" section with three buttons: "+ Add Role", "Expand All", and "Collapse All". The roles listed are:
 - Administrator:** Has full access
 - Monitor:** Cannot configure the engine, but otherwise has full access
 - Operator:** Has limited access to view data

At the bottom right of the configuration area, there are three buttons: "Close", "Apply to Other Engines", and "Apply".

2. Select *Enable third-party authentication*.

The screenshot shows the LiveWire OmnipEEK configuration interface. The top navigation bar includes a menu icon, the product name "LiveWire OmnipEEK", a settings gear icon, and a user profile icon labeled "admin". Below the navigation bar, the breadcrumb path is "Engines / Capture Engine / Configure Engine". The main navigation menu includes "Home", "Captures", "Forensics", "Files", "Forensic Searches", "Events", "Adapters", "Settings", and "Admin".

The "Security" section is expanded, showing the following options:

- Enable OS authentication only
- Enable third-party authentication
- Enable two-factor authentication
- Send audit log messages to syslog

The "Enable third-party authentication" option is selected and highlighted with a red box. Below this option is a table with two columns: "NAME" and "TYPE". The table currently contains one row with the text "No servers". Below the table, there is a red warning message: "Configure and enable at least one authentication server". An "Insert" button is located below the table.

The "Access Control" section is also expanded, showing the following options:

- Enable access control

Below the "Enable access control" option is a "Roles" section. It includes three buttons: "+ Add Role", "Expand All", and "Collapse All". The roles are listed in a table:

Role	Description	Actions
Administrator	Has full access	Expand/Collapse icons
Monitor	Cannot configure the engine, but otherwise has full access	Expand/Collapse icons
Operator	Has limited access to view data	Expand/Collapse icons

At the bottom of the configuration window, there are three buttons: "Close", "Apply to Other Engines", and "Apply".

3. Click **Insert**. The **Edit Authentication Setting** dialog appears.

The screenshot shows the LiveWire OmnipEEK configuration interface. The top navigation bar includes a menu icon, the product name "LiveWire OmnipEEK", a settings gear icon, and a user profile icon labeled "admin". Below the navigation bar, the breadcrumb trail reads "Engines / Capture Engine / Configure Engine". A secondary navigation bar contains links for "Home", "Captures", "Forensics", "Files", "Forensic Searches", "Events", "Adapters", "Settings", and "Admin".

The main content area is divided into two sections:

- Security:** This section has a dropdown arrow. It contains two radio button options: "Enable OS authentication only" (unselected) and "Enable third-party authentication" (selected). Below these is a table with columns "NAME" and "TYPE". The table currently contains one row with the text "No servers". A red-bordered box highlights an "Insert" button located below the table. A red text warning below the table reads "Configure and enable at least one authentication server". Below the table are three checkboxes: "Enable two-factor authentication" (unselected), "Send audit log messages to syslog" (unselected), and "Enable access control" (checked).
- Access Control:** This section also has a dropdown arrow. It features a "Roles" section with three buttons: "+ Add Role", "Expand All", and "Collapse All". Below these buttons are three role cards, each with an expand/collapse arrow, a role name, a description, and edit/delete icons:
 - Administrator:** Has full access
 - Monitor:** Cannot configure the engine, but otherwise has full access
 - Operator:** Has limited access to view data

At the bottom right of the configuration panel, there are three buttons: "Close", "Apply to Other Engines", and "Apply".

4. Select *Active Directory* as the *Type* of authentication setting. The settings for the Active Directory appear and must be configured.

EDIT AUTHENTICATION SETTING ×

NAME

TYPE

Active Directory

SERVER ADDRESS/HOSTNAME

May be a Hostname/IP address, or a Hostname/IP address and a port separated by a colon
Must be non-empty and cannot contain any of the special characters ",~!@#%*&():"

PROTOCOL

LDAP

BASE DN

Must be non-empty

APPLICATION USERNAME

Must be non-empty

APPLICATION PASSWORD

Must be non-empty

- Once the settings are configured, click **Test Connection** to test the Active Directory connection.

EDIT AUTHENTICATION SETTING ×

NAME

TYPE

Active Directory

SERVER ADDRESS/HOSTNAME

May be a Hostname/IP address, or a Hostname/IP address and a port separated by a colon
Must be non-empty and cannot contain any of the special characters ",~!@#%*&():"

PROTOCOL

LDAP

BASE DN

Must be non-empty

APPLICATION USERNAME

Must be non-empty

APPLICATION PASSWORD

Must be non-empty

Test Connection **Test User**

Cancel **OK**

6. Click **Test User** to check if a particular user exists within the specified Active Directory.

EDIT AUTHENTICATION SETTING ×

NAME

TYPE

Active Directory

SERVER ADDRESS/HOSTNAME

May be a Hostname/IP address, or a Hostname/IP address and a port separated by a colon
 Must be non-empty and cannot contain any of the special characters ",~!@#%*&():"

PROTOCOL

LDAP

BASE DN

Must be non-empty

APPLICATION USERNAME

Must be non-empty

APPLICATION PASSWORD

Must be non-empty

Test Connection **Test User**

Cancel OK

7. Click **OK**.

When Upgrading From LiveWire v23.3.1 or Earlier

When upgrading from LiveWire v23.3.1 or earlier to LiveWire v23.4.0 or later, there are two possible upgrade scenarios that affect the Access Control List (ACL):

- If you are upgrading from LiveWire 23.3.1 or earlier, and the ACL policy list is empty (no users are assigned to any of the policies), regardless of whether ACL is enabled or disabled:

In this case, upon upgrading to v23.4.0 or later, LiveWire automatically upgrades the ACL from the policy-based approach to the role-based approach described in this chapter.

- If you are upgrading from LiveWire 23.3.1 or earlier, and the Access Control List policy list is NOT empty (at least one user is assigned to at least one policy), regardless of whether ACL is enabled or disabled:

In this case, upon upgrading to v23.4.0 or later, LiveWire keeps the policy-based approach. You will need to manually opt-in to the role-based approach. If you decide to upgrade to a role-based approach, and upon your confirmation, LiveWire completely clears the current ACL settings and forces you to redefine your ACL settings using the role-based approach as explained in this chapter.

The screenshot shows the 'Access Control' configuration page in LiveWire Omnipeek. The page has a blue header with the LiveWire Omnipeek logo and navigation links: Home, Captures, Forensics, Files, Forensic Searches, Events, Adapters, Settings, Admin. The main content area is titled 'Access Control' and features a checkbox for 'Enable access control' which is checked. Below this is a table with two columns: 'POLICY' and 'USERS'. The table lists various permissions and the users assigned to them. At the bottom of the table, a button labeled 'Convert Access Control To Roles' is highlighted with a red border. A 'Close' button is visible in the bottom right corner of the configuration area.

POLICY	USERS
Allow Capture Engine usage	admin, local_user_1, local_user_2, LivePCAUser1
Capture: Create new capture	admin, local_user_1, LivePCAUser1
Capture: Delete captures created by other users	admin, local_user_1, LivePCAUser1
Capture: Start/stop captures created by other users	admin
Capture: Modify captures created by other users	admin
Capture: View captures created by other users	admin, local_user_1, LivePCAUser1
Capture / Forensic Search: View packets from captures and forensic searches created by other users	admin, local_user_1, LivePCAUser1
Capture / Forensic Search: View statistics from captures and forensic searches created by other users	admin, local_user_1, LivePCAUser1
Capture: Delete files created by other users	admin
Configuration: Configure engine settings	admin
Configuration: View the audit log	admin, local_user_2
Configuration: Upload files	admin, local_user_2
Configuration: Download packet data	admin, local_user_2
Forensic Search: Create new forensic search	admin, local_user_1, LivePCAUser1
Forensic Search: Delete forensic searches created by other users	admin, local_user_1, LivePCAUser1
Forensic Search: View forensic searches created by other users	admin, local_user_1, LivePCAUser1

Convert Access Control To Roles

CONVERT ACCESS CONTROL TO ROLES

Are you sure you would like to clear your current Access Control settings and begin using roles?

No Yes

Capture Adapters for LiveWire

In this chapter:

<i>About capture adapters</i>	148
<i>1G capture adapter</i>	148
<i>10G capture adapter</i>	149
<i>40G capture adapter</i>	151
<i>100G capture adapter</i>	152
<i>Enabling PTP support for capture adapters</i>	153
<i>Connecting the external time synchronization adapter</i>	156
<i>Troubleshooting the capture adapters</i>	156

About capture adapters

The capture adapters for LiveWire (LiveWire Core/PowerCore only) are high performance network analysis cards that allow you to perform advanced recording, monitoring and troubleshooting of Gigabit, 10 Gigabit, and 40 Gigabit Ethernet networks. The capture adapters for LiveWire are available in the following configurations:

- 1G capture adapter—Four port PCI Express Gigabit adapter (see '1G capture adapter' on page 148)
- 10G capture adapter—Two or four port 10 Gigabit adapter (see '10G capture adapter' on page 149)
- 40G capture adapter—Two port 40 Gigabit adapter (see '40G capture adapter' on page 151)
- 100G capture adapter—Two port 100 Gigabit adapter (see '100G capture adapter' on page 152)

If your capture adapter supports Precision Time Protocol (PTP), instructions for manually enabling PTP support and connecting the PTP adapter on LiveWire are included.

For more information on using capture adapters with LiveWire and Omnipeek, please refer to the documentation and online help that ships with the Omnipeek. Additionally, the LiveAction website has up-to-date software and support at <https://www.liveaction.com>.

1G capture adapter

The 1G capture adapter is a four port PCI Express Gigabit adapter that supports up to four half-duplex Gigabit Ethernet channels (two full-duplex links). The 1G capture adapter can be connected via taps, matrix switches, or at a switch span port. Taps and matrix switches provide completely passive monitoring that does not affect the network, even in power loss conditions.

1G capture adapter I/O bracket

The I/O bracket of the 1G capture adapter has four SFP cages, a time synchronization connector, and status LEDs. The SFP cages accommodate either fiber or copper modules, which allows you to match different media for your network: copper, single mode fiber (SX), multi-mode fiber (LX), and 10/100/1000 Base-T.

Note Each SFP cage accommodates a single SFP module (not included). A pair of SFP modules are required for full-duplex links.

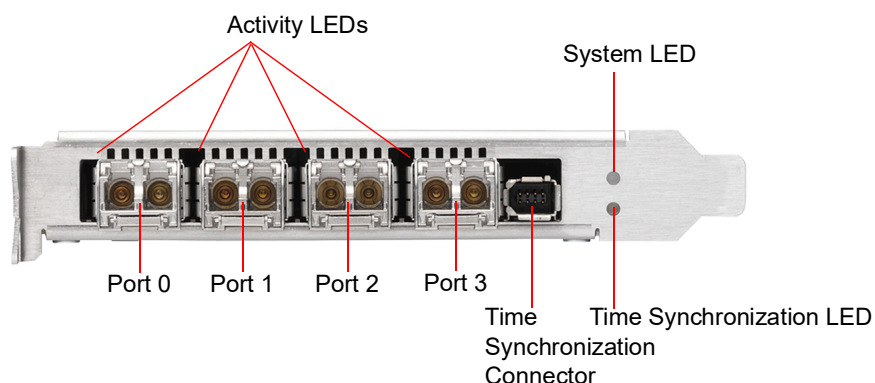

LED status

The following table describes the LED status on the 1G capture adapter.

LED	State and Color	Condition
System LED	Off	The power is off.
	Constant red	During start-up: Power is on. The adapter is checking the power supplies.
	Flashing red	After start-up: The power is on. There is a fatal hardware error.
	Constant yellow	During start-up: The power is on. The power supplies are working.
	Flashing yellow	There is a new entry in the hardware log.
	Constant green	The FPGA is loaded, and the system is running.
Activity LEDs	Off	The driver is not loaded, the Ethernet link is down, or the port is disconnected.
	Constant Green	The driver is loaded and the Ethernet link is up, but there is no RX or TX traffic.
	Flashing Green	The driver is loaded and there is RX or TX traffic on the Ethernet link
External Time Synchronization LED	Off	No driver is loaded, or no valid PPS or NT-TS signal is detected or generated on the SMA port of the external time synchronization connector, and the Ethernet link on the PTP port is down.
	Constant yellow	The Ethernet link on the PTP port is up.
	Flashing green synchronous with the PPS or NT-TS pulse	The Ethernet link on the PTP port is down and the following condition is fulfilled: When the SMA port of the external time synchronization connector is configured as a: <ul style="list-style-type: none"> • PPS or NT-TS input connector: A driver is loaded, and a valid PPS or NT-TS signal as relevant is detected. • PPS or NT-TS output connector: A driver is loaded, and a PPS or NT-TS signal is generated.
	Yellow with flashing green synchronous with the PPS or NT-TS pulse	The Ethernet link is up. When the corresponding time synchronization connector is configured as a: <ul style="list-style-type: none"> • PPS or NT-TS input connector: A driver is loaded, and a valid PPS or NT-TS signal as relevant is detected. • PPS or NT-TS output connector: A driver is loaded, and a PPS or NT-TS signal is generated

10G capture adapter

The 10G capture adapter is a two or four port 10 Gigabit adapter specifically designed to handle 10 Gigabit capture and analysis. Capturing 10 Gigabit network traffic, it can slice and filter packets in order to focus the traffic stream and optimize analysis. The 10G capture adapter can be used in fiber environments, or via SPAN or mirror ports.

The 10G capture adapter is available in the following configurations:

- Two or four 850nm MMF SFP+ optical transceivers with LC connectors
- Two or four 1310nm SMF SFP+ optical transceivers with LC connectors

Note If you are using a variable rate 1 GB SFP+, you will need to cd into `/opt/Napatech/bin` and issue the following command to set the port rate to 1 GB:

```
config --cmd set --port 1 --speed 1G
```

10G capture adapter (2-port) I/O bracket

The I/O bracket of the 10G capture adapter (2-port) has two SFP+ cages, a time synchronization connector, and status LEDs. Each SFP+ cage accommodates a single SFP+ module. A pair of SFP+ modules are required for full-duplex links.

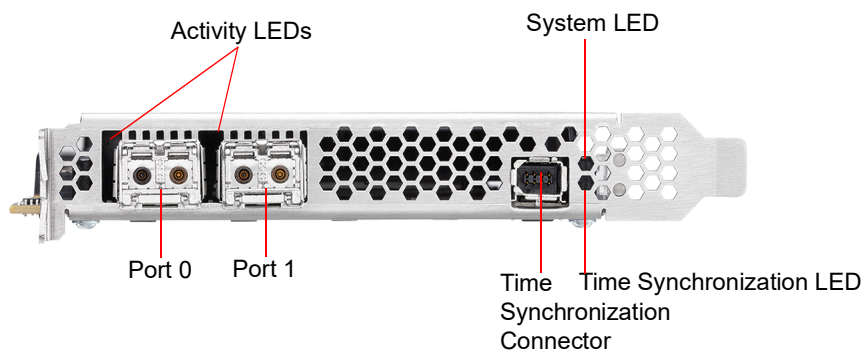

10G capture adapter (4-port) I/O bracket

The I/O bracket of the 10G capture adapter (4-port) has four SFP+ cages, a time synchronization connector, and status LEDs. Each SFP+ cage accommodates a single SFP+ module (not included). A pair of SFP+ modules are required for full-duplex links.

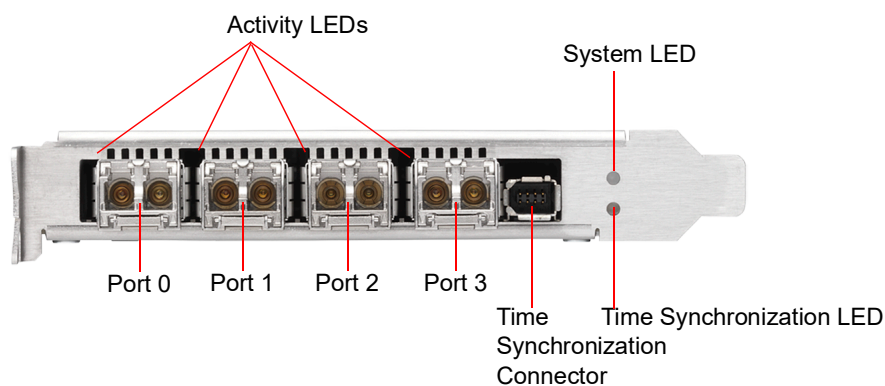

LED status

The following table describes the LED status on the 10G capture adapter.

LED	State and Color	Condition
System LED	Off	The power is off.
	Constant red	During start-up: Power is on. The adapter is checking the power supplies.
	Flashing red	After start-up: The power is on. There is a fatal hardware error.
	Constant yellow	During start-up: The power is on. The power supplies are working.
	Flashing yellow	There is a new entry in the hardware log.
	Constant green	The FPGA is loaded, and the system is running.
Activity LEDs	Off	The driver is not loaded, the Ethernet link is down, or the port is disconnected.
	Constant Green	The driver is loaded and the Ethernet link is up, but there is no RX or TX traffic.
	Flashing Green	The driver is loaded and there is RX or TX traffic on the Ethernet link

LED	State and Color	Condition
External Time Synchronization LED	Off	No driver is loaded, or no valid PPS or NT-TS signal is detected or generated on the SMA port of the external time synchronization connector, and the Ethernet link on the PTP port is down.
	Constant yellow	The Ethernet link on the PTP port is up.
	Flashing green synchronous with the PPS or NT-TS pulse	The Ethernet link on the PTP port is down and the following condition is fulfilled: When the SMA port of the external time synchronization connector is configured as a: <ul style="list-style-type: none"> • PPS or NT-TS input connector: A driver is loaded, and a valid PPS or NT-TS signal as relevant is detected. • PPS or NT-TS output connector: A driver is loaded, and a PPS or NT-TS signal is generated.
	Yellow with flashing green synchronous with the PPS or NT-TS pulse	The Ethernet link is up. When the corresponding time synchronization connector is configured as a: <ul style="list-style-type: none"> • PPS or NT-TS input connector: A driver is loaded, and a valid PPS or NT-TS signal as relevant is detected. • PPS or NT-TS output connector: A driver is loaded, and a PPS or NT-TS signal is generated.

40G capture adapter

The 40G capture adapter is a two port, PCI Express 40 Gigabit adapter with optical interfaces that are optimized for recording, monitoring, and troubleshooting traffic on 40 Gigabit Ethernet networks. The 40G capture adapter provides tracing and dynamically configurable filtering together with high precision time-stamping. The 40G Adapter is available with two QSFP+ interfaces.

40G capture adapter I/O bracket

The I/O bracket of the 40G capture adapter has two QSFP+ cages, a time synchronization connector, and status LEDs. Each QSFP+ cage accommodates a single QSFP+ module (not included).

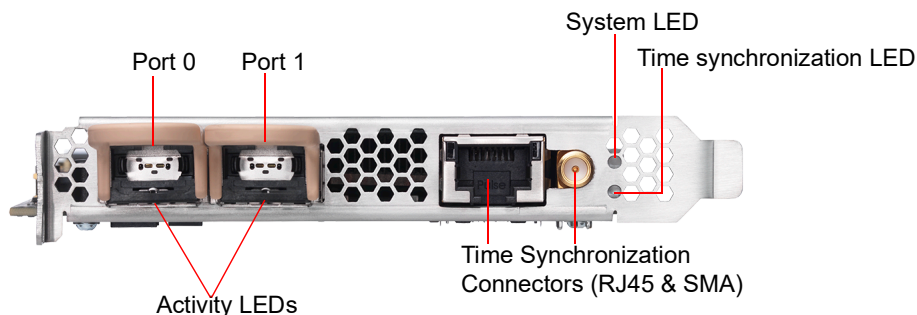

LED status

The following table describes the LED status on the 40G capture adapter.

LED	State and Color	Condition
System LED	Off	The power is off.
	Constant red	During start-up: Power is on. The adapter is checking the power supplies.
	Flashing red	After start-up: The power is on. There is a fatal hardware error.
	Constant yellow	During start-up: The power is on. The power supplies are working.
	Flashing yellow	There is a new entry in the hardware log.
	Constant green	The FPGA is loaded, and the system is running.

LED	State and Color	Condition
Activity LEDs	Off	The driver is not loaded, the Ethernet link is down or the port is disconnected.
	Constant Green	The driver is loaded and the Ethernet link is up, but there is no RX or TX traffic.
	Flashing Green	The driver is loaded and there is RX or TX traffic on the Ethernet link
External Time Synchronization LED	Off	No driver is loaded, or no valid PPS or NT-TS signal is detected or generated.
	Constant Yellow	The Ethernet link on the external RJ45 time synchronization connector is up.
	Flashing green synchronous with the PPS or NT-TS pulse	The Ethernet link on the external RJ45 time synchronization connector is down, and the following condition is fulfilled: When the external SMA time synchronization connector is configured as a: <ul style="list-style-type: none"> • PPS or NT-TS input connector: A driver is loaded, and a valid PPS or NT-TS signal as relevant is detected. • PPS or NT-TS output connector: A driver is loaded, and a PPS or NT-TS signal is generated.
	Yellow with flashing green synchronous with the PPS or NT-TS pulse	The Ethernet link on the external RJ45 time synchronization connector is down, and the following condition is fulfilled: When the external SMA time synchronization connector is configured as a: <ul style="list-style-type: none"> • PPS or NT-TS input connector: A driver is loaded, and a valid PPS or NT-TS signal as relevant is detected. • PPS or NT-TS output connector: A driver is loaded, and a PPS or NT-TS signal is generated.

100G capture adapter

The 100G capture adapter is a two port, PCI Express 100 Gigabit adapter with optical interfaces that are optimized for recording, monitoring, and troubleshooting traffic on 100 Gigabit Ethernet networks. The 100G capture adapter provides tracing and dynamically configurable filtering together with high precision time-stamping. The 100G capture adapter is available with two QSFP28 interfaces.

Note Both a 25G and 80G capture adapter configuration that is based on the 100G capture adapter form factor are also available. If you are interested in obtaining either a 25G or 80G capture adapter configuration, please contact LiveAction Technical Support.

100G capture adapter I/O bracket

The I/O bracket of the 100G capture adapter has two QSFP28 cages, a time synchronization connector, and status LEDs. Each QSFP28 cage accommodates a single QSFP28 module (not included).

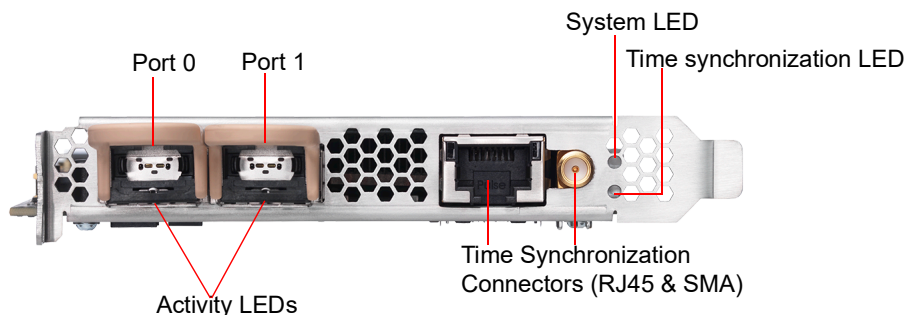

LED status

The following table describes the LED status on the 100G capture adapter.

LED	State and Color	Condition
System LED	Off	The power is off.
	Constant red	During start-up: Power is on. The adapter is checking the power supplies.
	Flashing red	After start-up: The power is on. There is a fatal hardware error.
	Constant yellow	During start-up: The power is on. The power supplies are working.
	Flashing yellow	There is a new entry in the hardware log.
	Constant green	The FPGA is loaded, and the system is running.
Activity LEDs	Off	The driver is not loaded, the Ethernet link is down or the port is disconnected.
	Constant Green	The driver is loaded and the Ethernet link is up, but there is no RX or TX traffic.
	Flashing Green	The driver is loaded and there is RX or TX traffic on the Ethernet link
External Time Synchronization LED	Off	No driver is loaded, or no valid PPS or NT-TS signal is detected or generated.
	Constant Yellow	The Ethernet link on the external RJ45 time synchronization connector is up.
	Flashing green synchronous with the PPS or NT-TS pulse	The Ethernet link on the externalRJ45 time synchronization connector is down, and the following condition is fulfilled: When the external SMA time synchronization connector is configured as a: <ul style="list-style-type: none"> • PPS or NT-TS input connector: A driver is loaded, and a valid PPS or NT-TS signal as relevant is detected. • PPS or NT-TS output connector: A driver is loaded, and a PPS or NT-TS signal is generated.
	Yellow with flashing green synchronous with the PPS or NT-TS pulse	The Ethernet link on the externalRJ45 time synchronization connector is down, and the following condition is fulfilled: When the external SMA time synchronization connector is configured as a: <ul style="list-style-type: none"> • PPS or NT-TS input connector: A driver is loaded, and a valid PPS or NT-TS signal as relevant is detected. • PPS or NT-TS output connector: A driver is loaded, and a PPS or NT-TS signal is generated.

Enabling PTP support for capture adapters

The capture adapters for LiveWire support the Precision Time Protocol (PTP). This protocol allows the adapters to sync to a time source on the network that may be more accurate than the clock on LiveWire. If you have multiple capture adapters, you can sync the adapters to a single clock source, as well as allow the packets received on the adapters to have more accurate timestamps. See also 'Synchronizing the capture engine clock' on page 155.

To enable PTP support for the adapters, you must manually edit a config file and restart some services on the Capture Engine. The instructions for enabling PTP support on the Capture Engine are provided below.

To enable PTP support on the Capture Engine:

1. SSH into the Capture Engine.
2. Stop the Capture Engine service.
 - `service omnid stop`
3. Open the file `/etc/omni/ntservice.ini`
 - This file uses the INI format.

- The file is broken up into sections. Each section has a name wrapped in [] (e.g [Adapter0]), all of the fields below the section name apply to that section.
4. Find the adapter section corresponding to the adapter you wish to configure. Make note of the section name.
 - Adapter sections have section names which follow the format [AdapterN] where N is a number starting at 0 and incremented by one for each Napatech adapter present on the system.
 5. Close the /etc/omni/ntservice.ini file.
 6. Open the file /etc/omni/ntoverrides.ini
 - This file has the same format as the /etc/omni/ntservice.ini file.
 - This file is used to override the default settings of configuration parameters in the /etc/omni/ntservice.ini file.
 7. Add the section name of the adapter retrieved in the /etc/omni/ntservice.ini file.
 8. Below this section, add the necessary PTP configuration parameters.
 - If more than one card is being configured, add the next section name and the necessary PTP configuration parameters.
 9. When all of the adapters have been configured, save and close the file.
 10. Run the ntcards_setup script to update the configuration file with the PTP settings.
 - service ntcards_setup start
 - This script may take a couple of minutes to complete.
 11. Once the script is finished, restart the Capture Engine service.
 - service omnid start

Configuration parameters

The minimum configuration parameters that must be set to enable PTP on an Adapter for LiveWire are described in the table below. For more complex configurations, contact LiveAction Tech Support to get a full list of all the PTP configuration parameters supported.

Note *PtpIpAddr*, *PtpGw* and *PtpNetmask* are only applicable if *PtpDhcp* is set to DISABLE. If *PtpDhcp* is set to ENABLE the static IP configuration parameters should not be added to the configuration file.

Section	Parameters	Description	Values	Default Value
System	TimeSyncOsTimeReference	This option can be used to synchronize the OS Time to a Napatech adapter clock The chosen adapter cannot specify OSTime as one of the options in the TimeSyncReferencePriority field	None - adapter-0 - adapter-1 - adapter-2...	None
AdapterN	PtpDhcp	Enables/disables DHCP support on the PTP port. Set to DISABLE if a static IP address will be used.	ENABLE - DISABLE	DISABLE
AdapterN	PtpIpAddr	Specifies a static IP address for the PTP port.	Any valid IPv4 address (e.g. 192.168.1.10)	Not set

Section	Parameters	Description	Values	Default Value
AdapterN	PtpGw	Specifies a gateway address for the PTP port.	Any valid IPv4 address (e.g. 192.168.1.10)	Not set
AdapterN	PtpNetMask	Specifies the netmask for the static address specified with PtpIPAddr.	Any valid IPv4 netmask (e.g. 255.255.255.0)	Not set
AdapterN	PtpUnicastMasterAddr<1...10>	Adds an IP address of a PTP master to the unicast master table. Up to 10 IP addresses can be added. The order of the addresses is not important.	Any valid IPv4 address (e.g. 192.168.1.10)	Not set
AdapterN	TimeSyncReferencePriority	Comma separated list of clock sources. In order to enable PTP, PTP must be the first item in the list. The last item in the list must be either FreeRun or OSTime.	PTP - Ext1 - FreeRun - OSTime	OSTime

Example of /etc/omni/ntoverrides.ini:

```
## This file is used to specify overrides for the ntservice configuration file
#
## Option to synchronize OS time to a Napatech adapter clock:
## Note: The selected accelerator must not have OSTime included in the
## TimeSyncReferencePriority parameter, nor must it be synchronized to an accelerator
## in OS synchronization mode.
[System]
TimeSyncOsTimeReference = adapter-1

#
# Example for Configuring Multicast:
[Adapter0]
PtpDhcp = ENABLE
# Last item in list must be FreeRun or OSTime, cannot include both in the list:
TimeSyncReferencePriority = PTP, OSTime

##
# Example for Configuring Unicast using a Static IP Address:
[Adapter1]
PtpDhcp = DISABLE
PtpIpAddr = 192.168.1.15
PtpGw = 192.168.1.1
PtpNetMask = 255.255.255.0
PtpUnicastMasterAddr1 = 192.168.1.13
PtpUnicastMasterAddr2 = 192.168.1.29
TimeSyncReferencePriority = PTP, FreeRun
```

Synchronizing the capture engine clock

If PTP support is enabled on the capture adapter in a PTP network environment, to prevent inaccurate time-stamps from being reported, ensure that the Capture Engine's clock is synchronized with the PTP or NTP server (if NTP's time source is pointed at the PTP grandmaster clock).

To synchronize the Capture Engine clock, one of the following configurations is needed:

- Enable 'TimeSyncOsTimeReference' in `/etc/omni/ntoverrides.ini`—This option synchronizes the OS time to a Napatech adapter clock, which in turn should be configured to point to the PTP grandmaster clock as its time reference
- If NTP server references PTP as its time source, run 'ntpd' to synchronize the OS time with the NTP server, and then start up the NTP daemon

Connecting the external time synchronization adapter

For the capture adapters for LiveWire that support the Precision Time Protocol (PTP), a time synchronization adapter is included with your adapter. One end of the time synchronization adapter is connected to the external time synchronization connector on the capture adapter; the other end of the time synchronization adapter is connected to your PTP source via an Ethernet or GPS connection (blue cable).

Note For instructions on manually enabling PTP support on your Capture Engine, see 'Enabling PTP support for capture adapters' on page 153.



Troubleshooting the capture adapters

When the connection for one or more channels is down or degraded, you can use a known good test cable to connect the card to itself in order to facilitate troubleshooting and help to isolate the source of trouble.

Verifying link status

1. Remove the cables from two of the channels and replace with a crossover test cable connected as shown below:

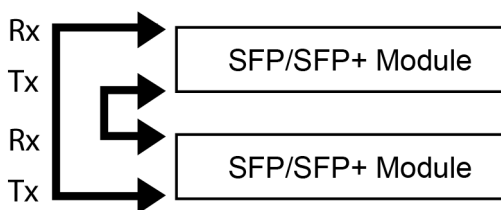

2. If the two links are established, this will indicate that both channels, including the SFP/SFP+ modules, are functional. An external connection issue should then be investigated.

If both links are NOT established using the Link Status test steps above, users of fiber SFP/SFP+ modules may attempt a further test to isolate individual SFP/SFP+ modules.

Note Both the Rx and Tx sides of the connection are contained in a single jack for 1000Base-TX SFPs/SFP+ modules. The following steps can only be used to test fiber SFP (SX or LX) and SFP+ modules, which have separate Rx and Tx connectors.

To test fiber SFP/SFP+ modules individually:

1. Connect the crossover test cable as shown below:



2. Each channel should auto-negotiate with itself, turning its Link Status LED on.
3. If a single failing channel is identified, substitute the corresponding channel's SFP/SFP+ module.
4. If substitution of the SFP/SFP+ modules does not resolve the problem, replace the card.

Network Port Requirements

In this appendix:

<i>LiveWire/Omnipeek Port Information</i>	159
<i>NetFlow (NetFlow v5, NetFlow v9, and IPFix) (optional)</i>	159
<i>iDRAC (out-of-band LiveWire management) Default Port Requirements</i>	159

LiveWire/Omnipeek Port Information

Port	Protocol	Usage
22	TCP/UDP	SSH (device management; optional: tcpdump capabilities)
25	TCP/UDP	SMTP (optional alerting method)
49	TCP/UDP	TACACS (optional)
80	TCP	HTTP (optional: not recommended for use – should be closed/blocked)
88	TCP/UDP	Kerberos KDC (optional)
161	TCP/UDP	SNMP (optional)
443	TCP	HTTPS
514	TCP/UDP	RSYSLOG (optional)
749	TCP/UDP	Kerberos Admin Server (optional)
1812	TCP/UDP	RADIUS (optional)
2812	TCP	Monit (optional: can be TLS encrypted)
6367	TCP	LiveAction WP Omni protocol
6370	TCP	Capture Engine Manager
8443	TCP	HTTPS

NetFlow (NetFlow v5, NetFlow v9, and IPFix) (optional)

Port	Protocol	Usage
2055	UDP	Netflow v5 & v9
4739	TCP/UDP	IPFix

iDRAC (out-of-band LiveWire management) Default Port Requirements

Port	Protocol	Usage
22*	TCP	SSH
23*	TCP	Telnet (not recommended for use – should be closed/blocked)
80*	TCP	HTTP (not recommended for use – should be closed/blocked)
161*	UDP	SNMP
443*	TCP	HTTPS
623	UDP	RCMP/RCMP+
5900*	TCP	Virtual Console keyboard and mouse redirection, virtual media, virtual folders, and remote file share
5901	TCP	VNC (when VNC feature is enabled, the port 5901 opens)
*configurable port		

Hardware Specifications

In this appendix:

<i>LiveWire technical specifications</i>	161
<i>Capture adapter technical specifications</i>	164

LiveWire technical specifications

LiveWire Edge

Specification	Description
Processor	Intel® Atom® C3758
Base Frequency	2.2 GHz
Cores	8
Memory	16 GB DDR4 2400 MHz ECC DIMM
Storage	1 x 1 TB SSD
I/O	(4) RJ45 LAN (GbE) (2) RJ45 Inline bypass ports (GbE) (2) USB 3.0 ports (1) Console port (Mini USB) (1) On/Off switch (1) Reset button (3) Status LEDs
Physical	
Dimensions:	8.54-by-1.7-by-5.7-inches (217-by-44-by-145.5-millimeters)
Unit Weight:	2.64 lbs (1.2 kg)
Shipping Weight:	6.61 lbs (3 kg)
System Cooling	
Processor:	Passive CPU Heat sink
System:	Fanless
	NOTE: Do not place anything on top of or directly next to LiveWire Edge. Any obstructions to the heat sink located on top of LiveWire Edge can cause the unit to overheat.
Power Supply	60 W Power adapter 100-240 V @50-60 Hz
Operating Environment	
Operating Temperature:	32° to 104° F (0° to 40° C)
Storage Temperature:	-4° to 158° F (-20° to 70° C)
Relative Humidity:	5% to 90% (non condensing)
Storage Humidity:	5% to 95% (non condensing)
Regulations	EMC CE Class B FCC Class B RoHS UL

LiveWire Core

Specification	Description
Processor	AMD® 1x7313
Base Frequency	3.0 GHz
Cores	16
Thread	32
Memory	64 GB RAM
Expansion Slots	1 x 16 full-height PCI Express 3.0 slot
	NOTE: A total of one capture adapter can be added to the LiveWire Core.
Integrated Network Interfaces	4 x 1GBASE-T iDRAC
Storage-OS	Included as part of Storage-Data
Storage-Data	Available with 32 TB SAS ISE storage, RAID 0 with optional RAID 10
Chassis	1U Rackmount
Dimensions (WxHxD):	17.08 x 1.68 x 28.98-inches (433.8 x 42.7 x 736.3-millimeters)
Weight:	48.1 lbs (21.8 kg) maximum
System Cooling	Five chassis cooling fans (hot-pluggable)
System Input Requirements	
AC Input Voltage:	100-240 V AC
Rated Input Current:	7.4 A-3.7 A
Rated Input Frequency:	50-60 Hz
Power Supply (2 units)	
Rated Output Power:	800 W
Operating Environment	
Operating Temperature:	50° to 95° F (10° to 35° C)
Non-operating Temperature:	-40° to 149° F (-40° to 65° C)
Operating Relative Humidity:	10% to 80% (non condensing)
Non-operating Relative Humidity:	5% to 95% (non condensing)
Heat dissipation (maximum):	3000 BTU/Hours

LiveWire PowerCore

Specification	Description
Processor	AMD® 2x EPYC 73F3
Base Frequency	3.5 GHz
Cores	32
Thread	64
Memory	256 GB RAM
Expansion Slots	Eight available PCI Express 3.0 slots to support up to three high speed capture adapters
Integrated Network Interfaces	4 x 1GBASE-T iDRAC
Storage-OS	Two 2 TB SSD SAS ISE drives for OS
Storage-Data	200 TB SAS storage, RAID 6 (240 TB, optional RAID 0) NOTE: Optional external storage with LiveWire TeraVault — Up to 800 TB, RAID 6 (960 TB, optional RAID 0) of additional storage (4x 2U TeraVaults)
Chassis	Rack-mount 2U appliance
Dimensions (WxHxD):	17.09 x 3.42 x 28.99 in. (434 x 86.8 x 715.5 mm)
Weight:	Up to 80 lb (36.3 kg) maximum
System Input Requirements	
AC Input Voltage:	100-240 V AC, autoranging
Rated Input Frequency:	50/60 Hz
Power Supply (2 units)	
Rated Output Power:	1100 W
Operating Environment	
Operating Temperature:	50° to 95° F (10° to 35° C)
Non-operating Temperature:	-40° to 149° F (-40° to 65° C)
Operating Relative Humidity:	10% to 80% (non condensing)
Non-operating Relative Humidity:	5% to 95% (non condensing)
Heat dissipation (maximum):	4100 BTU/Hour

Important! WARNING: Slide/rail mounted equipment is not to be used as a shelf or a work space.

AVERTISSEMENT: Le matériel monté sur rails/coulisseaux ne doit pas être utilisé comme étagère ou espace de travail.

LiveWire StorageCore

Specification	Description
Processor	(2) Intel Xeon Gold 6326
Base Frequency	2.9 GHz
Cores	16
Threads	32
Memory	192 GB RAM
Expansion Slots	Four available PCI Express 3.0 slots to support up to three high speed capture adapters
Integrated Network Interfaces	2x10G Base-T ports
Storage-OS	Two 960 GB SSD drives for OS
Storage-Data	1.4 PB SAS storage, RAID 6 or optional RAID 0
Chassis	4U server chassis
Dimensions (WxHxD):	17 x 7 x 38.4 in. (434 x 176 x 974.7 mm)
Weight:	Up to 218 lb. (99.1 kg) maximum
System Input Requirements	
AC Input Voltage:	100-240 V AC
Rated Input Frequency:	50-60 Hz
Rated Input Current:	100 (12 A) – 240 V (10 A)
Power Supply (2 units)	
Rated Output Power:	1600 W redundant power supply C13/C14, 0.6 M, 250 V, 13 A power cords (2)
Operating Environment	
Operating Temperature:	32° to 95° F (0° to 35° C)
Non-operating Temperature:	-4° to 140° F (-20° to 60° C)
Operating Relative Humidity:	20% to 80% (non condensing)
Non-operating Relative Humidity:	10% to 90% (non condensing)

Capture adapter technical specifications

1G capture adapter specifications

Specification	Description
Network Interfaces	
Standard:	IEEE 802.3 1 Gbps Ethernet support
Physical interface:	4x SFP ports
Supported SFP modules	Multi-mode SX (850 nm), single-mode LX (1310 nm), single-mode ZX (1550 nm), 1000BASE-T or 10/100/1000BASE-T

Specification	Description
Environment	
Power consumption:	23.3 Watts including SFP SX modules
Operating temperature:	32° F to 113° F (0° to 45° C)
Operating humidity:	20% to 80%
Regulatory approvals and compliances	CE CB RoHS REACH cURus (UL) FCC CSA VCCI C-TICK

10G capture adapter (2-port) specifications

Specification	Description
Network interfaces	
Standard:	IEEE 802.3 10 Gbps Ethernet LAN
Physical interface:	2 x SFP or SFP+ ports
Supported SFP modules:	Multi-mode SX, single-mode LX and ZX, 1000BASE-T or 10/100/1000BASE-T
Supported SFP+ modules:	Multi-mode SR, single-mode LR and ER, 10GBASE-CR
Supported dual-rate modules:	Multi-mode SR and single-mode LR
Environment	
Operating temperature:	32°F to 113°F (0° to 45°C)
Operating humidity:	20% to 80%
Regulatory approvals and compliances	CE CB RoHS REACH cURus (UL) FCC CSA VCCI C-TICK

10G capture adapter (4-port) specifications

Specification	Description
Network interfaces	
Standard:	IEEE 802.3 10 Gbps Ethernet LAN
Physical interface:	4x SFP or SFP+ ports
Supported SFP modules:	Multi-mode SX, single-mode LX and ZX, 1000BASE-T or 10/100/1000BASE-T
Supported SFP+ modules:	Multi-mode SR, single-mode LR and ER, 10GBASE-CR
Supported dual-rate modules:	Multi-mode SR and single-mode LR
Environment	
Power consumption:	27 Watts including SFP+ SR modules
Operating temperature:	32° F to 113° F (0° C to 45° C)
Operating humidity:	20% to 80%
Regulatory approvals and compliances	PCI-SIG® CE CB RoHS REACH cURus (UL) FCC CSA VCCI C-TICK

40G capture adapter specifications

Specification	Description
Network interfaces	
Standard:	IEEE 802.3 40 Gbps Ethernet LAN
Physical interface:	2x QSFP+ ports
Supported optical transceivers:	
Supported QSFP+ modules:	40GBASE-SR4, 40GBASELR4, and 40GBASE-SR-BiDi
Supported QSFP28 modules:	100GBASE-SR4 and 100GBASE-LR4
Environment	
Operating temperature:	32°F to 113°F (0° to 45°C)
Operating humidity:	20% to 80%
Regulatory approvals and compliances	PCI-SIG® NEBS level 3 CE CB RoHS REACH cURus (UL) FCC ICES VCCI C-TICK

100G capture adapter specifications

Specification	Description
Network interfaces	
Standard:	IEEE 802.3 40 Gbps Ethernet LAN
Physical interface:	2x QSFP+ ports
Supported optical transceivers:	
Supported QSFP+ modules:	40GBASE-SR4, 40GBASELR4, and 40GBASE-SR-BiDi
Supported QSFP28 modules:	100GBASE-SR4 and 100GBASE-LR4
Environment	
Operating temperature:	32°F to 113°F (0° to 45°C)
Operating humidity:	20% to 80%
Regulatory approvals and compliances	PCI-SIG® NEBS level 3 CE CB RoHS REACH cURus (UL) FCC ICES VCCI C-TICK